

C E M I N T E L[®]



Edge Cladding



EDGE[™] CLADDING + SIMPLELINE[®]
Installation Guide



01

INTRODUCTION

TABLE OF CONTENTS

01 INTRODUCTION	2	07 INSTALLATION	25
Introduction	2	Checklist – Prior to Installation	25
02 PRODUCT OVERVIEW	3	Installation Considerations	26
Panel Information	3	Installation of Wall Wrap	29
Applications	3	Installation – Direct Fix System	31
Benefits of Cemintel Edge and SimpleLine Wall Systems	3	Installation – Cavity Fix System	32
Product Specifications	4	Installers Installation Checklist	33
03 SYSTEM OVERVIEW	5	08 CONSTRUCTION DRAWINGS + DETAILS	34
Direct Fix and Cavity Fix Cladding Systems	5	Edge Cladding + SimpleLine Vertical Installation – Direct Fix System	34
Cavity Battens and Top Hats	6	Edge Cladding + SimpleLine Vertical Installation – Cavity Fix System	47
Air Barriers	6	Edge Cladding Horizontal Installation – Direct Fix	61
04 DESIGN + AESTHETIC CONSIDERATIONS	7	Edge Cladding Horizontal Installation – Cavity Fix	64
Design Considerations – Facades & Cladding Systems	7	09 SAFETY, HANDLING + GENERAL CARE	66
Panel Layout	7	Health, Safety and PPE	66
Sheet Layout of Openings	7	Handling & General Care	66
Control Joints	7	10 WARRANTY, CLEANING + MAINTENANCE	67
Jointing Solutions & Surface Finish	8	Warranty	67
05 COMPONENTS + ACCESSORIES	9	Wash Down Process	67
06 SYSTEM ENGINEERING	14	Inspection, Repair and Maintenance	67
Design, Detailing and Performance Responsibilities	14		
Batten and Top Hat Arrangements	16		
Design Tables	17		

Introduction

Edge™ Cladding (“Edge”) and SimpleLine® (“SimpleLine”) are hidden gems in the Cemintel® (“Cemintel”) portfolio. Pre-primed, pre-sealed, external cladding sheets with modern sharp-edge expressed groove architectural styling allows for creative application of the product that pairs fantastically with the whole Cemintel range.

The grooves are very sharp and clean, so you don’t have to remove burring before you paint – it’s ready to go. The ship-lap joint runs along the long edge and allows for frame movement and avoids joint cracking. The sheets are suitable for gun-nailing for fast and efficient installation and good coverage. The cladding can be installed direct on studs or as a cavity system. The direct fix method creates a narrow wall that saves space and time.

As well as facades, Edge and SimpleLine can also be used in customised solutions for eaves, ceilings, soffits and internal linings. Contact DesignLINK for information on these applications.

This installation guide has been prepared as a general guide and includes information on design and installation considerations, system engineering and construction details. It assumes that the user has an intermediate knowledge level of building design and construction. In no way does it replace the services of the building professionals required to design projects. Nor is it an exhaustive guide of all possible scenarios. It is the responsibility of the architect, designer and various engineering parties to ensure that the details in this installation guide are appropriate for the intended application. For further design information this guide should be read in conjunction with the CSR Cemintel Facades and Cladding – Design Guide and CSR Gyprock® The Red Book™ publications.

PRODUCT OVERVIEW

02

Panel Information

Edge cladding sheets are fibre cement sheets featuring a modern sharp-edge expressed groove design. Edge cladding is manufactured from an advanced lightweight fibre cement. The grooves are available in a range of spacings, including 75mm, 150mm, 300mm and 400mm, to accentuate a regular linear design and provide a modern alternative to the traditional weatherboard patterns. Edge cladding can be installed either vertically or horizontally.

SimpleLine are large format sheets with expressed grooves at the edges to provide a simple, smooth and expansive modern aesthetic. SimpleLine cladding is manufactured from fibre cement.

Edge and SimpleLine sheets both conform to the requirements of AS2908.2 – Cellulose-cement products, Part: 2 - Flat sheets, Category 3 Type A.

SimpleLine is a vertically installed cladding system.

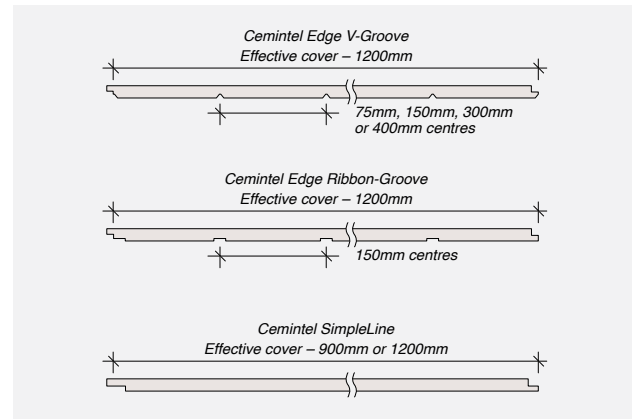

Applications

Edge and SimpleLine cladding systems are designed for residential projects, and can be used in many external applications including:

- New homes;
- Upper and lower storey additions;
- Composite construction;
- Gable ends;
- Infill sheets around windows and doors;
- Outbuildings including garages and tool-sheds; and
- Over-cladding of existing walls.

Edge and SimpleLine cladding is typically installed on timber or steel framed Class 1 and 10 residential buildings in accordance with the relevant Australian Standards, and is suitable for wind zones N1 to N6/C4 in accordance with AS4055: Wind loads for housing.

Additionally, Edge and SimpleLine systems can be installed on Class 2 to Class 9 buildings of a Type C Construction. Type A and B Construction buildings will require a Cavity Fix wall system with steel top hats and non-combustible components. The support frame and fixing arrangements for a range of design ultimate limit state wind pressures are provided in this guide.

Benefits of Cemintel Edge and SimpleLine Wall Systems

- Simple and quick to install using standard building methods;
- Direct fixed option, where the cladding is direct fixed to studs over wall wrap/sarking;
- Drained and ventilated cavity option where the cladding is fixed to battens over wall wrap/sarking delivers superior weatherproofing by more effectively managing moisture;
- Nail-gun fixing to timber framing or screw fixing to steel framing;
- Edge Cladding can be installed either vertically or horizontally;
- SimpleLine Cladding is a vertically installed system;
- Manufactured from highly durable and robust fibre cement;
- Immune to permanent water damage;
- Will not rot;
- Low maintenance;
- Termite resistant;
- Fire resistance – Fibre cement sheets can be used where non-combustible material is required under BCA provisions;
- Systems are available for thermal, acoustic and fire requirements as part of an overall solution;
- Bushfire Performance – BAL 29, for a standard wall, and BAL FZ Flame Zone when a 'fire-rated plasterboard' wall system is installed;
- Resistant to cracking, swelling and warping;
- Grooved Edge sheets provide a modern aesthetic and an alternative to the traditional weatherboard;
- Edge sheets are coated with sealers on all surfaces and supplied with an exterior face ready for paint finishing;
- Smooth, flat sheets complemented with discrete ship-lap joints make SimpleLine a cost effective alternative to render; and
- SimpleLine sheets have a pre-sealed exterior face to easily accept all types of exterior paint finished.

02

PRODUCT OVERVIEW

Product Specifications

Edge cladding sheet is 9mm thick, has a nominal cover of 1200mm and is available in a range of lengths and expressed groove patterns. Sheets are manufactured with ship-lap profiled long edges for joining. Sheets have a repeating pattern of 1.8mm depth x 8.6mm width 'rectangular' profile grooves at a 150mm spacing on the external face, and 2.8mm depth x 5.5mm width 'V' profile grooves on the external face, which are available in a range of spacings 75mm, 150mm, 300mm and 400mm centres. Edge sheets are supplied with a factory sealed face ready for paint finishing.

Edge Cladding is available in 5 sharp and distinct designs that can be used both internally and externally for dramatic effect. It is perfect for the creative pairing with other materials, as part of a composite look, or as a vertical alternative to the traditional weatherboard.

Edge Cladding can be installed either vertically or horizontally.

SimpleLine cladding is 8.5mm thick, has a nominal cover of either 900mm or 1200mm and is available in a range of lengths. Sheets are manufactured with a ship-lap profiled long edges for joining. Sheets have a repeating pattern of 3.5mm depth x 6mm width grooves at sheet joints on the external face. SimpleLine has a pre-sealed face that easily accepts all types of exterior paint finishes.

SimpleLine cladding is a vertically installed system.



Property	Performance	Reference/Relevant Standard
Thickness	-0mm / +0.3mm	AS 2908.2
Width	-1mm / +0mm	AS 2908.2
Length	-3mm / +0mm	AS 2908.2
EMC Panel Mass (Nominal)	13.1 kg/m ² (Edge) 12.5 kg/m ² (SimpleLine)	AS 2908.2
Fire Resistance Limits (FRLs)	Up to 90/90/90 in a system with Gyprock fire grade plasterboard	Refer to System Engineering section of Gyprock® The Red Book™
Bushfire Construction	BAL 29 (Construction for Bushfire Attack Level 29 for a standard external wall). Higher BAL ratings are possible with the inclusion of fire-rated layers.	AS 3959
Weatherproofing	Assessed to pass serviceability pressure of 1.19kPa based on ventilated cavity systems	BCA Vol 1 Verification Method FV1.1 and BCA Vol 2 Verification Method V2.2.1
Cyclonic Conditions	Suitable for wind classification up to C4	AS 4055 (Wind loads for housing)

EMC – Equilibrium Moisture Content

SYSTEM OVERVIEW

03

Direct Fix and Cavity Fix Cladding Systems

Edge and SimpleLine wall systems have ship-lap joints to create the expressed groove at the joint and continue the regular expressed groove appearance on the external face of the Edge sheets. The sheets are easily fixed to timber or steel frames using common fasteners. Panels can be either installed by DIRECT FIXED to the framing or installed with a ventilated and drained CAVITY, depending on the degree of weather resistance required. The cavity system provides a beneficial path for airflow, ventilation and drainage.

Direct Fix System

In many Australian residential applications (where homes are low rise and subject to low wind pressures), cladding is fixed directly to the frame. A degree of sealing is required at joints and gaps to prevent water ingress. Although not as effective as ventilated and drained cavity systems, direct fix systems can be an effective means of weatherproofing low risk buildings.

Drained and Ventilated Cavity Fix System

For buildings that are subject to higher wind loads or have features associated with a higher risk level for weatherproofing, a ventilated and drained cavity is required (refer to NCC BCA Volume 2, Part 2.2 Damp and Weatherproofing (Verification Methods), Table V2.2.1a – Risk Factors and Scores). Typically, a ventilated and drained cavity or “Rainscreen” has openings at the joints that provide a rear-ventilated cladding system. To achieve a ventilated system, battens or top hats are fixed over an air barrier to the face of studs or structural framing to form a cavity to enable air flow at the base and/or head of the external cladding wall via J-Track and eaves, respectively.

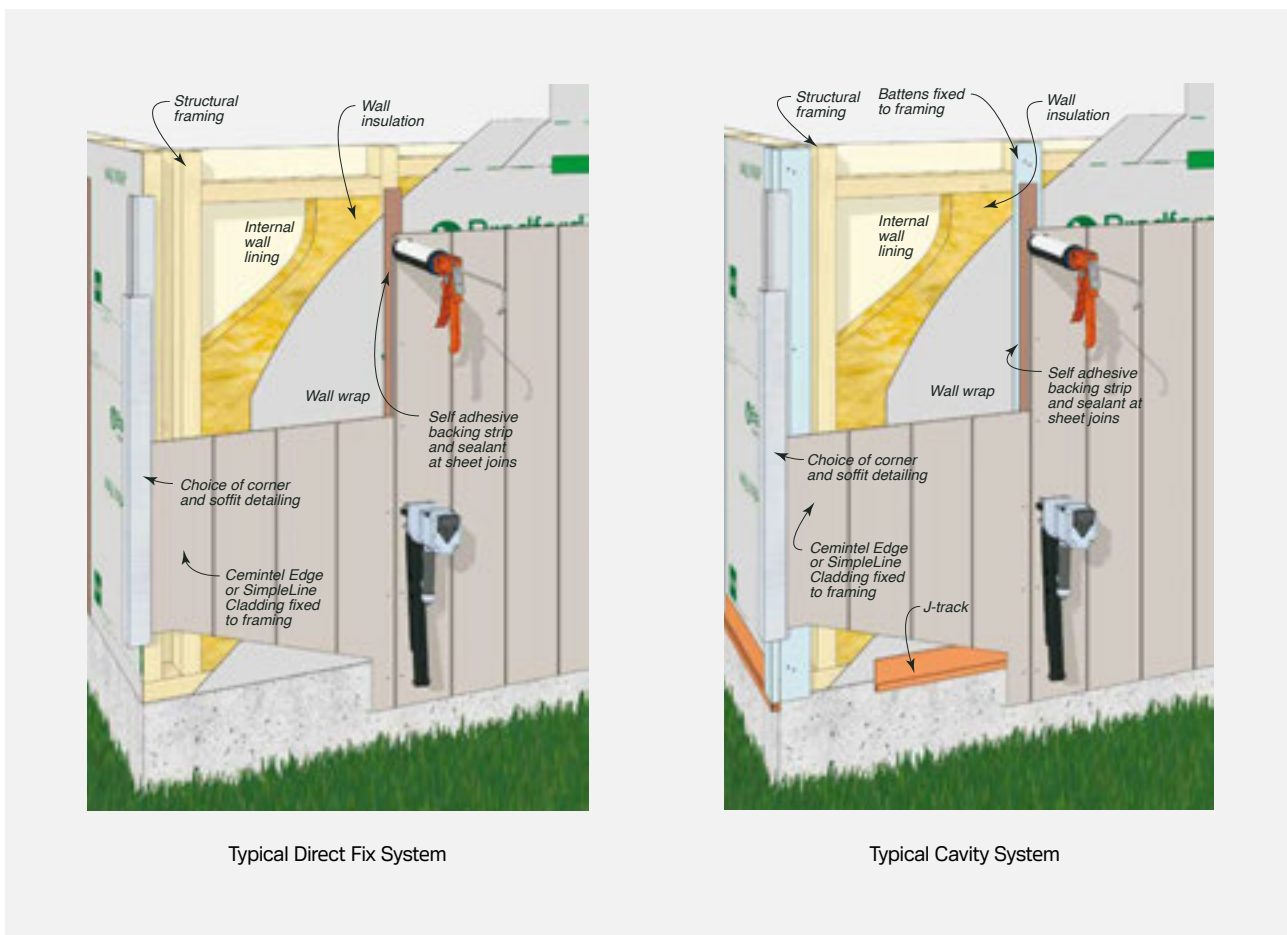
FIGURE 3.01 Typical Direct Fix System and Cavity Fix System Arrangements

* Refer to page 61 for Edge cladding horizontal installation drawings and details.

03

SYSTEM OVERVIEW

Design and installation considerations are provided in this guide for both methods. A unique weatherproofing solution can be also achieved through a combination of these two methods.

The weatherproofing performance of the cavity is further enhanced by allowing sufficient air flow into the cavity behind the cladding, so that the pressures on either side of the cladding are similar and creates a pressure equalised cavity. This feature reduces the risk of moisture and water entering the cavity by means of pressure equalisation and provides a path for any water that does enter the cavity to effectively drain away and evaporate, leaving the building shell dry.

The weatherproofing performance of the Edge and SimpleLine wall systems have been assessed and independently certified. For further information contact CSR DesignLINK.

Cavity Battens and Top Hats

The cavity can be formed with the following batten/top hat components:

- Non-structural – 18mm to 20mm deep/thick timber battens with a minimum 35mm – 70mm face width;
- Structural – 18mm to 50mm deep steel top hats with a 35mm minimum face width, 19mm deep Cemintel FC Batten (Residential Class 1 and 10 buildings only), or 35mm to 50mm deep timber battens with a minimum 35mm – 70mm face width; and
- At vertical joints (Vertically installed Edge and SimpleLine cladding) – studs or battens must have a minimum face width of 45mm.
- At vertical joints (Vertically installed Edge and SimpleLine cladding) - Double stud spacing or wider battens are required to accommodate fixings.

The non-structural battens are fixed 'On-stud' to the structural framing and acts as a spacer with the Edge and SimpleLine cladding direct fixed to the framing. For structural battens and top hats, the Edge and SimpleLine cladding can be direct fixed to batten or top hats. Note, for steel framed buildings the designer will advise on the thermal break requirements. The timber battens will require a minimum H3 protective treatment. The steel top hats will require a protective treatment or stainless steel material in C4: High Corrosivity Zone and higher zones. Horizontal surfaces of battens must have a minimum fall of 5° to the horizontal to allow drainage of any moisture.

FIGURE 3.02 Air Flow in the Ventilated Cavity Fix System

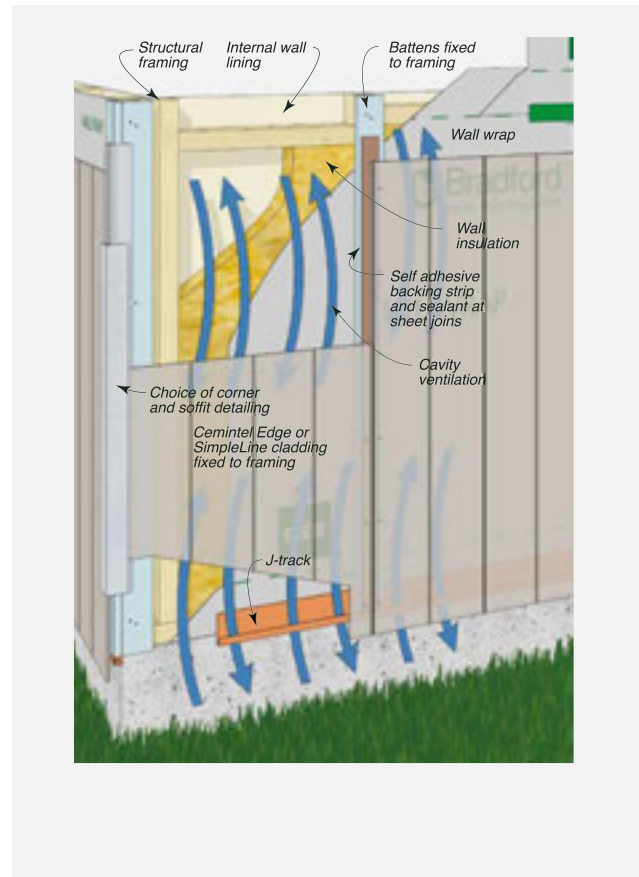

Air Barriers

The air barrier is required to reduce air leakage between the exterior and interior areas of the building to achieve the pressure equalised self-draining cavity system and the 'building envelop sealing' level for energy efficiency performance. This guide considers the internal plasterboard lining as the predominant air barrier. Refer to the CSR Cemintel Facades and Cladding – Design Guide and CSR Gyprock The Red Book literature for further information on plasterboard linings, and Edge and SimpleLine wall systems.

In high wind areas or Risk Factors, an appropriate securely fixed air barrier (i.e., wall wrap, rigid air barrier, waterproofing layer, backpan of a cavity wall system) will be required as a replacement air barrier to the internal plasterboard lining.

Further information on the air barrier requirements to achieve a pressure equalisation system are presented in Cemintel Air Barriers – Design and Installation Guide.

DESIGN + AESTHETIC CONSIDERATIONS

04

This guide provides detailed installation information for external wall systems clad with Edge and SimpleLine sheets over timber, steel, concrete or masonry construction. This section outlines some important areas for consideration in determining an appropriate design of the Edge and SimpleLine clad facade. The following points are not exhaustive. It is the responsibility of the architect / building designer to ensure the design conforms to BCA requirements and other relevant building standards that may exist for that location. It is recommended that the architect/building designer assigns the responsibility for the façade design to the project engineer.

This installation guide should be read in conjunction with the BCA, and for design information presented in the CSR Cemintel Facades and Cladding – Design Guide and CSR Gyprock The Red Book publications.

Design Considerations – Façades and Cladding Systems

CSR recommends that a comprehensive assessment of the performance requirements for the facades and external wall cladding systems be undertaken to address the areas of:

- Structural Design – framing and substrate options, direct fix and cavity fix installation requirements, earthquake loading, wind loading, stud set-out, cyclonic zones, structural bracing, internal linings and curved walls;
- Weatherproofing;
- Moisture Management – condensation risk, wall wrap/sarking selection and air barriers;
- Energy Efficiency/Thermal Design – thermal performance, thermal break requirements, building envelop sealing and thermal bridging;
- Climates Zones for Thermal Design;
- Fire Resistance Performance – fire rated external wall systems, supplementary fire zone protection, wall framing fire resistance, framing and lining, spread of fire, bushfire prone zones and roof & eaves design;
- Acoustic Performance;
- Extreme Climate Conditions – coastal areas, corrosive zones/ categories and temperature extremes; and
- Other Design Considerations – window selection, services, renovations, termite management, specialist profiles and product limitations.

Panel Layout

The Edge sheets can be installed with the joins in either a vertical or horizontal orientation. SimpleLine sheets must be installed with the joins in a vertical orientation. All Sheet joints must be backed by framing, battens or top hats. For the direct fix method, it is critical that the layout of the stud framing be determined to coincide with the vertical joint of a full sheet width, as the pre-formed ship-lap joints can not be produced on-site.

Sheet Layout of Openings

Penetrations in the Cemintel cladding must be neatly cut using appropriate tools such as a saw, drill or hole saw. Penetrations should be prepared with a clearance of 5mm all around and the gap must be fully sealed with sealant.

Control Joints

Control joints are installed in the system to allow differential movement and provide relief at high stress locations, which can include:

- Openings and penetrations (i.e., windows and doorways);
- Internal re-entrant corners;
- Junctions of different structural elements and framing (i.e., wall-to-floor framing, wall-to-roof framing, framed construction-to-masonry wall, and framed additions or extensions to existing buildings). Refer to “Construction Drawings + Details”;
- At junctions of existing and new framing and cladding systems, the framing and cladding must be discontinuous at the junction. Refer to “Construction Drawings + Details”;
- Movement joints provided in framing should be carried through the cladding and support framing; and

04

DESIGN + AESTHETIC CONSIDERATIONS

- For two-storeys construction, a horizontal control joint should be provided at the upper floor level unless specifically stated to the contrary in the relevant product installation guide.

Frame shrinkage and building movement will require consideration by the building designer in all cases.

Where dark colours are to be used for coatings (i.e., absorptance ≥ 0.75 , as defined in BASIX), the control joint spacing should be reduced to 3,600mm maximum. Refer to 'Jointing Solutions & Surface Finish' section in 'Design + Aesthetic Considerations'.

Vertical Control Joints

Vertical control joints are recommended at the following locations:

- 5,400mm maximum spacing inclusive of external corners, and within 3,600mm maximum of external corners;
- The cladding should not extend around two (2) external corners without the installation of a control joint;
- Align with control joints in the supporting structure and anywhere of significant structural movement;
- Control joints must extend the full height of the cladding and must be constructed in accordance with "Construction Drawings + Details".
- At sheet joints that coincide with the edge of an opening;
- At corners of openings and penetrations of height greater than 900mm (i.e., large windows, doorways, sliding doors);
- All re-entrant corners;
- At junction of different or discontinuous structural framing or cladding, refer Fig 8.25;
- At sheet joints in slender areas of cladding (i.e., aspect ratio (length/width) ≥ 5), unless the supporting framing, battens or top hats bridge the joints and the cladding is fixed either side of the joint. Ideally the slender area of cladding should comprise of a single sheet;
- At the change in wall height that is greater than 20%;
- At breaks and discontinuity of the cavity battens or top hats.

At vertical control joints, provide two studs with a 15-20mm gap and sufficient gap between the cladding sheets to accommodate expected vertical and/or horizontal movements

Horizontal Control Joints

A horizontal control joint is required at every floor junction, and at the junction of wall framing and roof framing at gable ends to accommodate deflection, movement and shrinkage of framing. The magnitude of the deflection must be verified by the project engineer.

Horizontal control joints are commonly installed at the underside of the slab level. Where vertical battens or top hats are used to form a cavity behind cladding sheet, they are required to be broken (i.e., discontinuous) to allow for continuity of the horizontal control joint.

Refer Fig 8.21 to 8.23 and 8.54 to 8.57 for details.

Control Joint Filling

For best results, control joints should be filled with polyurethane sealant after the texture coating has been applied. Refer to the coating specification for instruction on the coating and accessories (i.e., corner beading, control joints, jointing) properties to satisfy the performance requirements of the project (i.e., durability, fire and non-combustibility).

Joint Solutions & Surface Finish

All products should be painted within three months of delivery to site. Edge and SimpleLine sheets must be dry before painting. The Edge sheets are supplied with a pre-sealed front face of the sheet. Cut edges should be pre-painted with Cemintel Edge Sealer.

Where Cemintel cladding products are exposed to the elements for more than three months from delivery, CSR recommends the application of a priming coat before applying the decorative coatings. Refer to the coating manufacturer's recommendations.

It is important to seek advice from the coating manufacturer to ensure you select the most appropriate and compatible products for Edge and SimpleLine. Considerations should include:

- Prior to the application of the external coating system, walls must be washed down with clean fresh water to remove salt spray build-up from sheets and fixings. Sheets must be allowed to dry before coating. Refer to Section 10 for additional information;
- The straightness of the substrate framing;
- Fasteners may be patched with CSR Wet Area Base Coat and finished flush with the external face surface, with any excess material removed before hardening;
- The movement joint systems for use with Edge and SimpleLine wall systems are appropriate for external use, e.g., UV stabilised;
- The durability of the weatherboard system can be improved by periodic inspection and maintenance. Inspections should include examination of the paint, flashings and seals;
- The durability of the system can also be increased by painting all exposed sealants to the sealant manufacturer's recommendations;
- A minimum of a two-coat coating systems suitable for use with Edge and SimpleLine systems are usually 100% acrylic, exterior grade, high performance, elastomeric membrane weatherproofing coatings; and
- Paint finishes must be maintained in accordance with the manufacturer's recommendations. Any cracked or damaged flashings or seals that would allow water ingress must be repaired immediately. Any damaged sheets must be replaced.

Refer to coating manufacturer to determine suitable coatings. Cemintel recommends using trained applicators that are approved by the coating manufacturer. It is the responsibility of the applicator to use the appropriate components and compounds adequate to eliminate cracking under normal building conditions.

COMPONENTS + ACCESSORIES

05



Note: Codes can change from time to time. Refer to the website for the current list of components prior to ordering.

Sheets

Product Code	Nominal Thickness (mm)	Width (mm)	Length (mm)	Mass	Sheets per Pack
EDGE CLADDING					
BOND V-Groove at 75mm centres					
454471	9	1200	2450	13.1kg/m ²	30
454504	9	1200	2750	13.1kg/m ²	30
454474	9	1200	3000	13.1kg/m ²	30
OXFORD V-Groove at 150mm centres					
454475	9	1200	2450	13.1kg/m ²	30
454476	9	1200	2750	13.1kg/m ²	30
454477	9	1200	3000	13.1kg/m ²	30
YORK V-Groove at 300mm centres					
454505	9	1200	2450	13.1kg/m ²	30
454479	9	1200	2750	13.1kg/m ²	30
454500	9	1200	3000	13.1kg/m ²	30
CROWN V-Groove at 400mm centres					
454501	9	1200	2450	13.1kg/m ²	30
454502	9	1200	2750	13.1kg/m ²	30
454503	9	1200	3000	13.1kg/m ²	30
RIBBON-Groove at 150mm centres					
115654	9	1200	2450	13.1kg/m ²	30
115655	9	1200	2750	13.1kg/m ²	30
115656	9	1200	3000	13.1kg/m ²	30
SIMPLELINE CLADDING					
136719	8.5	900	3000	12.5kg/m ²	30
136820	8.5	1200	2400	12.5kg/m ²	30
136861	8.5	1200	3000	12.5kg/m ²	30

Accessories









Note: The length of the fixings will need to be increased to ensure the same or greater embedment depth is obtained when additional layers are added, such as a Rigid Air Barrier (RAB), fire-rated linings, and/or thermal break materials. Nail fixing through multiple layers can be difficult and screw fixings are the preferred method of construction.

Product	Description	Size/Colour	Quantity	Product Code
CLADDING FIXINGS				
	Cladding Nails for Timber Framing and Battens – Machine driven nails, Class 3 Hot Dipped Galvanised (HDG) or Class 4 Stainless Steel (S/S). Used for direct fixing Edge and SimpleLine cladding to timber framing or 35mm minimum thickness structural timber battens.			
	• Paslode 2.5mmø x 45mm Ring Shank Coil Nail (30mm minimum embedment)	2.5mmø x 45mm	Supplied by others	
	• 2.8mmø x 40mm Gal. Clout nail (30mm minimum embedment)	2.8mmø x 40mm	Supplied by others	
	Cladding Nails for Timber Framing – Machine driven nails, Class 3 Hot Dipped Galvanised (HDG) or Class 4 Stainless Steel (S/S). Used for direct fixing Edge and SimpleLine cladding to timber framing. 30mm minimum embedment.			
	• Paslode 2.5mmø x 50mm Plain or Ring Shank Nail	2.5mmø x 50mm	Supplied by others	
	• ND50 Brad Nail S/S	2.5mmø x 50mm		
	Cladding Nails for Cemintel FC Batten – Machine driven nails, Class 3 or Class 4 Stainless Steel (S/S). Used for direct fixing Cemintel Edge and SimpleLine cladding to Cemintel FC Battens.			
	• C25 Brad Nail	16G x 25mm	Supplied by others	

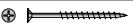
05

COMPONENTS + ACCESSORIES





Note: Codes can change from time to time. Refer to the website for the current list of components prior to ordering.

Product	Description	Size/Colour	Quantity	Product Code
CLADDING FIXINGS (CONT'D)				
	Cladding Nails for Timber Framing and Non-Structural Timber Battens – Machine driven nails, Class 3 Hot Dipped Galvanised (HDG) or Class 4 Stainless Steel (S/S). Used for direct fixing Cemintel Edge and SimpleLine cladding through 20mm maximum thickness non-structural timber battens to timber framing.			
	<ul style="list-style-type: none"> Paslode 2.5mmø x 60mm Smooth Shank nail Paslode 2.7mmø x 60mm Screw or Ring Shank Dome 15° nail 	2.5mmø x 60mm 2.7mmø x 60mm	Supplied by others	
	Cladding Screws for Steel Framing or Top Hats – Used for direct fixing Cemintel Edge and SimpleLine cladding to steel framing and steel top hats over a thermal break. To suit 0.50mm BMT to 1.15mm BMT framing.			
	<ul style="list-style-type: none"> Buildex Fibre Teks self-embedding CSK Rib head, Phillips drive, Climaseal 4 finish 	10-18 x 30mm (M4.8-18 x 30mm)	Pack of 1000 (loose)	125614
BATTEN AND TOP HAT FIXINGS				
	Batten Nails for Timber Framing – Manually driven nails, Class 3 Hot Dipped Galvanised (HDG). Used for fixing 35mm maximum thickness structural battens to timber framing.			
	<ul style="list-style-type: none"> Flat head nail, 30mm minimum embedment 	3.75mmø x 75mm	Supplied by others	
	Batten Nails for Timber Framing – Machine driven nails, Class 3 Hot Dipped Galvanised (HDG) or Class 4 Stainless Steel (S/S). Used for fixing 20mm maximum thickness non-structural battens to timber framing.			
	<ul style="list-style-type: none"> Paslode 2.8mmø x 50mm D Head nail 	2.8mmø x 50mm	Supplied by others	
	Batten Nails for Timber Framing – Machine driven nails, Class 3 Hot Dipped Galvanised (HDG) or Class 4 Stainless Steel (S/S). Used for fixing 35mm maximum thickness structural battens to timber framing.			
	<ul style="list-style-type: none"> Paslode 3.15mmø x 90mm D Head nail Paslode 3.15mmø x 90mm Screw or Ring Dome 15° nail 	3.15mmø x 90mm 3.15mmø x 90mm	Supplied by others	
	Batten Screws for Timber Framing – Used for fixing Cemintel FC Batten to timber framing.			
	<ul style="list-style-type: none"> Type 17 CSK Rib head, Phillips drive screw 	8-10 x 57mm	Supplied by others	
	Batten Screw for Steel Framing – Used for fixing the Cemintel FC Batten over a thermal break to steel framing. To suit 0.50mm BMT G550 steel and 0.75mm BMT G2 steel framing.			
	<ul style="list-style-type: none"> SCROOZ Fasteners FibreFix Metal FC Board screws, self-embedding head, SQ2-driver, Screw Armour Ceramic finish. 	8g x 42mm	Supplied by others	
	Batten Screw for Steel Framing – Used for fixing the Cemintel FC Batten over a thermal break or 35mm maximum thickness structural battens to steel framing. To suit 0.75mm BMT to 1.15mm BMT framing.			
	<ul style="list-style-type: none"> ProInx winged self-drilling, CSK self-embedding head, Class finish screw Otter (SLEG+) CSK Rib head, Phillips drive, GAL Class 3 finish. Cemintel FC Batten fixing. 	10-16 x 55mm 10-16 x 40mm	Pack of 500 (loose)	195881
	Top Hat Screws for Timber Framing – Used for fixing the intermediate top hat to timber framing.			
	<ul style="list-style-type: none"> Type 17, Hex head screw 	12-11 x 45mm	Supplied by others	
	Top Hat Screws for Steel Framing – Class 4 screw. Used for fixing intermediate top hat to steel framing over a thermal break, as required. To suit 0.50mm BMT to 1.15mm BMT framing.			
	<ul style="list-style-type: none"> Self-drilling Hex head screw 	12-14 x 20mm	Supplied by others	
	Cemintel FC Batten – Structural battens are fixed to the structural framing to create a 19mm deep drained cavity system. Thermal resistance, R-Value of 0.06 m ² .K/W.	70mm x 19mm 2.7m lengths	1 each	125431
	Timber H3 Batten – Non-structural timber battens are fixed to the structural framing to create a 19mm deep drained cavity system. 35mm minimum width and greater than stud framing width. (minimum of 20mm thick batten required for R-Value of 0.2 thermal break layer).	35mm min. x 18-20mm	Supplied by others	

COMPONENTS + ACCESSORIES

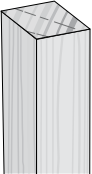
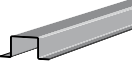
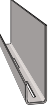
05

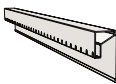
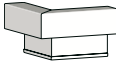
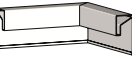
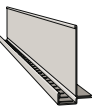
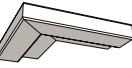





Note: Codes can change from time to time. Refer to the website for the current list of components prior to ordering.

Product	Description	Size/Colour	Quantity	Product Code
BATTEN AND TOP HAT FIXINGS (CONT'D)				
	<p>Structural Timber Battens – MGP10 grade, structural timber battens are used for support of the Edge cladding at vertical joints and create the 35mm deep drained cavity system.</p> <ul style="list-style-type: none"> Use 45mm (w) x 35mm (d) MGP10 for on-stud joints. Use 70mm (w) x 35mm (d) MGP10 for off-stud joints. May also be used as alternative to 45mm (w) x 35mm (d) battens. 	<p>45mm x 35mm F5 grade timber</p> <p>75mm x 35mm F5 grade timber</p>	<p>Supplied by others</p> <p>Supplied by others</p>	
	Cemintel® Intermediate Top Hat – Used for support and fixing of the Edge cladding at vertical joints in off-stud locations. Manufactured from galvanised (Z275) steel of 0.75mm base metal thickness with a mass of 0.95kg/m.	3.0m lengths x 35mm deep	1 each	126144
	J Track (Batten closer) – PVC extrusion fitted at base of battens to provide drainage, air flow and vermin proofing. To suit 18mm wide cavity.	18 x 18 x 70mm x 3000mm	1 each	134845
	Internal Corner Backing – metal angle flashing used at internal corners. Manufactured from steel galvalume AZ150 corrosion resistant coating. (reference: FC 133).	50x50x3030mm	1 each	111498
	Cemintel Eaves Trim – provides an attractive finish at eaves junction and provides cavity ventilation. Powder coat finish on 0.35mm BMT steel with Galvalume AZ150 corrosion resistant coating.	60 x 26mm x 3030mm White	1 each	134451
	Cemintel Eaves Trim External Corner – provides an attractive finish at eaves trim corner. Powder coat finish on 0.35mm BMT steel with Galvalume AZ150 corrosion resistant coating.	100 x 100mm White	1 each	134426
	Cemintel Eaves Trim Internal Corner – provides an attractive finish at eaves trim corner. Powder coat finish on 0.35mm BMT steel with Galvalume AZ150 corrosion resistant coating.	150 x 150mm White	1 each	134429
	Cemintel Soffit Trim – provides an attractive finish at soffit edge as well as cavity ventilation and cavity closure below battens. To suit 18mm wide cavity. Powder coat finish on 0.35mm BMT steel with Galvalume AZ150 corrosion resistant coating.	60 x 18mm x 3030mm White	1 each	134452
	Cemintel Soffit Trim External Corner – provides an attractive joint at soffit trim corner. To suit 18mm wide cavity. Powder coat finish on 0.35mm BMT steel with Galvalume AZ150 corrosion resistant coating.	76.5 x 76.5mm x 18mm White	1 each	134431
	Cemintel Soffit Trim Internal Corner – provides an attractive joint at soffit trim corner. To suit 18mm wide cavity. Powder coat finish on 0.35mm BMT steel with Galvalume AZ150 corrosion resistant coating.	91.5 x 91.5mm x 18mm White	1 each	134432
	Two Piece Corner – Snap together paintable aluminium corner. Can be used at internal and external corners to cover board ends	3m length	1	108451

05

COMPONENTS + ACCESSORIES

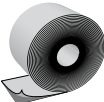

Note: Codes can change from time to time. Refer to the website for the current list of components prior to ordering.

Product	Description	Size/Colour	Quantity	Product Code
CEMINTEL RIGID AIR BARRIER/WALL WRAPS				
	Cemintel Rigid Air Barrier*	1200mm x 3000mm x 6mm	Pack of 30 sheets	170076
	Enviroseal™ Residential (RW) Classification – Class 4 Vapour Permeable	1500mm – 50m roll 1500mm – 30m roll	1 roll 1 roll	120923 192726
	Enviroseal™ Commercial (CW) Classification – Class 4 Vapour Permeable	1500mm – 50m roll	1 roll	118593
	Enviroseal™ Commercial (CW-IT) Classification – Class 4 Vapour Permeable	1500mm – 50m roll	1 roll	153675
	Thermoseal™ Wall Wrap Classification – Non-permeable Reflective Water Barrier	1350mm – 30m roll 1350mm – 60m roll	1 roll 1 roll	40483 10576
	Thermoseal™ Resiwrap Classification – Non-permeable Reflective Water Barrier	1350mm – 30m roll 1350mm – 60m roll 1500mm – 30m roll	1 roll 1 roll 1 roll	108879 108004 120121
	Enviroseal™ Hightack Tape – used to seal wall wrap/sarking at overlap joints, around openings and at flashings. Black, single sided, aggressive adhesive tape with a high initial grab and flexible carrier.	60mm x 25m	1 roll	160950
	Enviroseal™ SLS Tape – used to seal wall wrap/sarking at overlap joints, around openings and at flashings. Grey, single sided, aggressive adhesive tape with a high initial grab and flexible carrier.	60mm x 25m	1 roll	124872
INSULATION				
	Bradford Gold Wall Batts – R1.5 (75mm)	1160mm x 430mm 1160mm x 580mm	22 pack 22 pack	113938 113939
	Bradford Gold Wall Batts – R2.0 (HP) (75mm)	1160mm x 420mm 1160mm x 570mm	12 pack 12 pack	153643 153648
	Bradford Gold Wall Batts – R2.5 (90mm)	1160mm x 420mm 1160mm x 570mm	9 pack 9 pack	181430 181471
	Bradford Gold Wall Batts – R2.7 (90mm)	1160mm x 420mm 1160mm x 570mm	5 pack 5 pack	152191 152197
	Sealant – polyurethane. Used to seal joints, control joints, junctions, gaps around windows/doors/other penetrations. Can be painted over with most paints.	310mL tube (GREY) 310mL tube (BLACK)	1 each 1 each	11378 39488
	Backing Strip Tape – A self-adhesive closed cell flexible foam tape for water tightness across ship-lap joints. It is applied under sheet joints to the wall wrap (at stud locations) or to the face of the battens or top hats.	3.2 x 48mm x 23m roll	1 each	133978
	Backing Rod – 10mm polyethylene foam bead for insertion to joints prior to enable correct filling of joints with sealant. Also used as an air seal at window openings and construction junctions. The diameter of backing rod must be appropriate for the width of the gap being filled.	10mm diameter x 50m roll	1 each	11177
	Thermal Break – Extruded polystyrene strip with R-Value = 0.21. Used with steel stud framing to achieve min. NCC thermal break installed performance. Suitable for Class 1 and 10 residential and Type C Construction buildings only, and not suitable for fire-rated wall systems.	7mm x 38mm x 1250mm	1 each	466163

COMPONENTS + ACCESSORIES



05

Note: Codes can change from time to time. Refer to the website for the current list of components prior to ordering.

Product	Description	Size/Colour	Quantity	Product Code
	Cemintel Edge Sealer – for sealing panel edges after on-site cutting.	200ml	1 each	100166
		2ltr	1 each	180928
	Gyprock® Wet Area Base Coat – Used to fill and patch the fastener heads.	15kg	1	10146
Flashings and Cappings – flashings are to be designed and installed in accordance with SAA-HB39 1997 and good building practice.			Supplied by others	
* Cemintel Rigid Air Barrier can be made to order. Minimum order quantities and lead times apply. Refer to Cemintel for more information.				

Other Tools

CSR recommends the use of the following tools in conjunction with appropriate dust reduction methods.

Product	Description	Size	Quantity	Product Code
	Makita Plunge Saw Kit (1300W) includes 1400mm guide rail and bonus 165mm fibre cement saw blade – excellent for cutting cement based sheets	165mm	1	165485
	Makita 165mm Fibre Cement Saw Blade – ideal for use with the Makita Plunge saw and other 165mm circular saws fitted with vacuum extraction systems	165mmx20x4T	1	165486



SYSTEM ENGINEERING

Design, Detailing and Performance Responsibilities

Cemintel engages independent testing laboratories to test and report on the performance of a wall in accordance with the relevant Australian Standards. Consultants use these reports as the basis for opinions (estimates of laboratory performance) they issue for variations or different arrangements to the tested system. Using their experience, the consultant will make judgement about on-site installed performance of various walls.

Project Consultants (Structural, Fire, Acoustic, Façade etc.)

These consultants are typically responsible for the following:

- Opinions on expected laboratory performance of wall configurations that vary from actual test configuration, such as substitution products and components;
- Judgements about expected field performance using laboratory test reports and practical experience; and
- Design, specification and certification of structural, fire, acoustic, durability, weather tightness and any other required performance criteria for individual projects.

This involves the design and selection of building elements, such as wall and floors and their integration into the building considering the following:

- Interface of different building elements and to the structure / substrate;
- Wall and floor junctions;
- Penetrations;
- Flashing issues;
- Room / building geometry; and
- Acoustic and water penetration field-testing.

Design Responsibility

Cladding, air barrier, battens and top hats, and structural framing are required to resist wind and earthquake loads that are specific to the building and the site. Additional 'local pressure factors' can apply to cladding and the supporting battens and top hats in accordance with the Australian Standard AS/NZS 1170.2 – Wind actions. It is recommended that the Architect/Building Designer assigns the responsibility for the façade design to the Project Engineer. Once loads have been determined, the battens and top hat spans, fastener spacing, air barrier construction details, and cladding fixing details may be selected from the appropriate tables in this guide. It is also the responsibility of the Architect / Building Designer to select the appropriate corrosivity category. Refer to appropriate details in this guide.

The performance levels of walls documented in this guide and CSR Gyprock® The Red Book™ are either what is reported in a test or the documented opinion of consultants. Performance in projects is typically the responsibility of:

Project Certifier and/or Builder

These professionals are typically responsible for:

- Identifying the performance requirements for the project in accordance with the BCA and clearly communicating this to the relevant parties;
- Applicability of any performance characteristics supplied by Cemintel including test and opinions for the project; and
- The project consultant's responsibilities detailed above if one is not engaged in the project.

Cemintel does not provide consulting services. Cemintel only provides information that has been prepared by others and therefore shall not be considered experts in the field.

Any party using the information contained in this guide or supplied by Cemintel in the course of a project must satisfy themselves that it is true, current and appropriate for the application, consequently accepting responsibility for its use.

It is the responsibility of the architectural designer and engineering parties to ensure that the details in this design guide are appropriate for the intended application.

The recommendations in this guide are formulated along the lines of good building practice but are not intended to be an exhaustive statement of all relevant data.

Cemintel is not responsible for the performance of constructed walls, including field performance, and does not interpret or make judgements about performance requirements in the BCA.

Note: It is the responsibility of the Project Engineer/ Frame Designer to specify the connection of the structural noggings to the structural framing for off-stud top hats. It is also the responsibility of the project engineer to calculate the wind loads and earthquake loads for the cladding, air barrier and support framing of the façade on a project.



Edge Cladding // Bond



SimpleLine

Batten and Top Hat Arrangements

Stud Wall Support Framing – ‘On-Stud’ Fixing

Structural and non-structural timber battens and top hats may be fixed ‘On-stud’ to the stud of the structural wall framing designed from MGP10 or higher grade timber framing, or a minimum 0.50mm BMT steel framing. The battens and top hats should be arranged to not restrict the structural movement of the wall framing.

Stud frame walls designed to meet the structural requirements of the project, and designed to also support the Edge and SimpleLine cladding and associated battens and top hats.

FIGURE 6.01 Structural Timber Battens and Steel Top Hats Fixed to Studs of the Structural Framing – ‘On-Stud’ Fixing

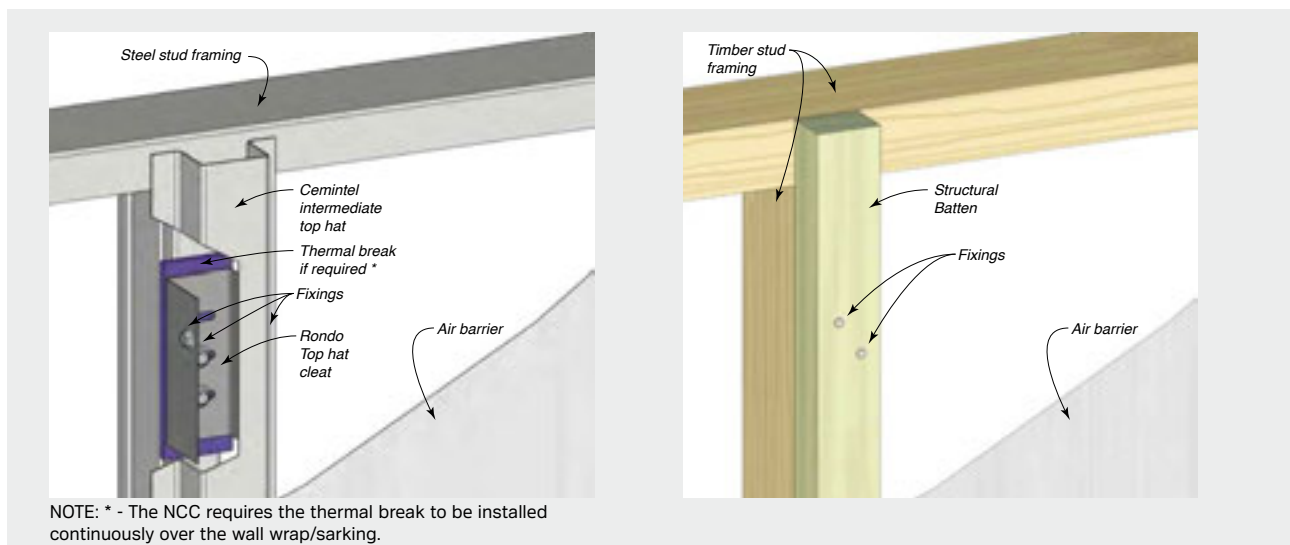

Horizontal Structural Wall Supports – ‘Off-Stud’ Fixing

Structural battens and steel top hats may be fixed ‘Off-stud’ to horizontal timber or steel structural support framing of a minimum 1.15mm BMT. It is the responsibility of the project engineer to specify this additional horizontal support structure and connections.

framing permit movement, such as deflection at an inter-storey junction, the wall framing will require additional horizontal structural supports near the plates for the batten and top hat end support. Also the battens and top hats will need to be discontinuous with an adequate gap to accommodate the structural movement.

Where the top plates and bottom plates of the structural

FIGURE 6.02 Structural Timber Battens and Steel Top Hats Fixed to Additional Horizontal Structural Supports – ‘Off-Stud’ Fixing

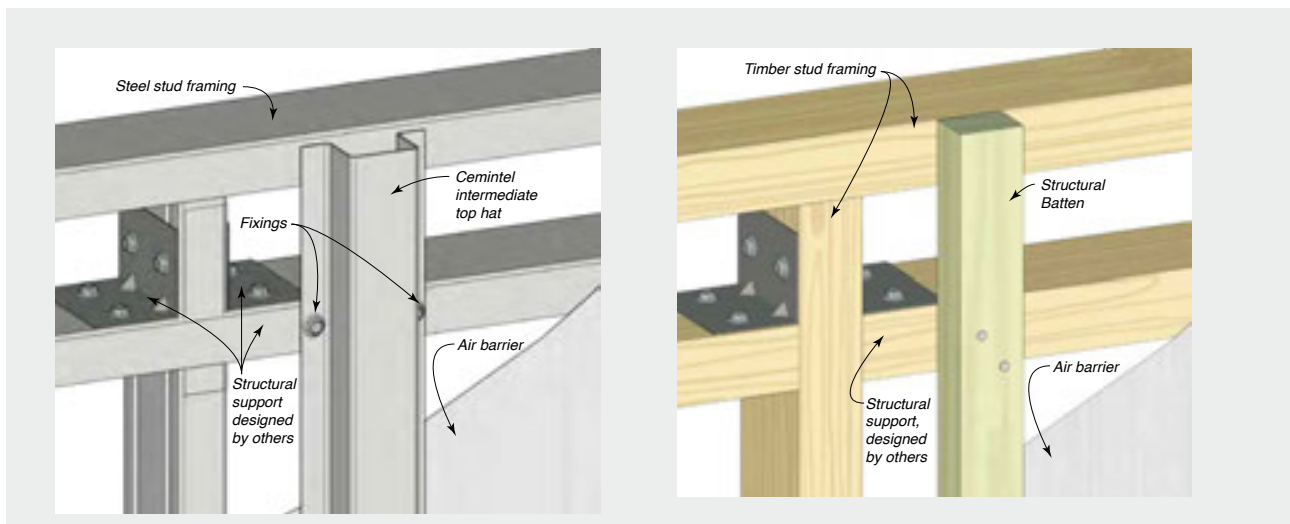

SYSTEM ENGINEERING

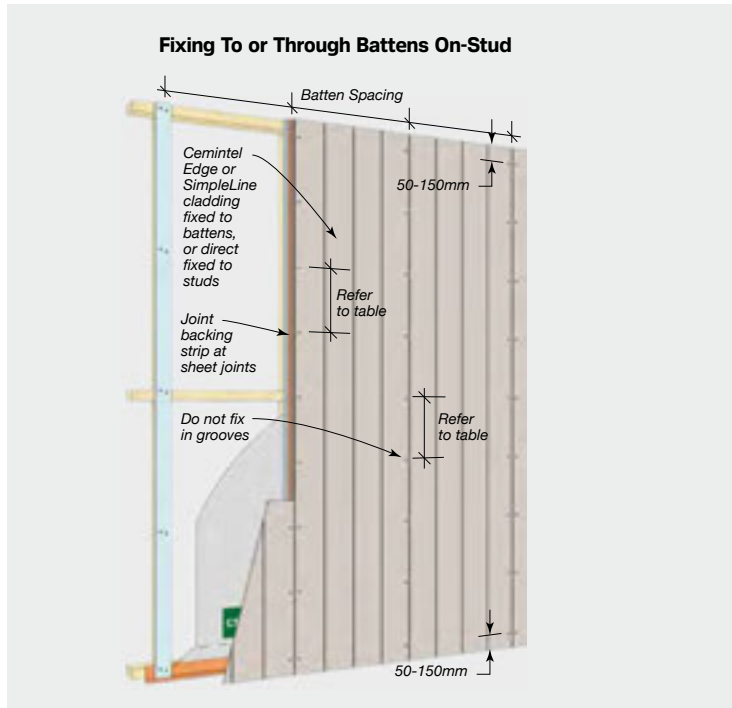

Design Tables

FIGURE 6.03 Fastener Spacing for Fixing Edge and SimpleLine Cladding

TABLE 6.01 Maximum Brad Nail Fastener Spacing for Fixing Cladding to Support Framing – AS4055 Compliant Buildings

IMPORTANT: This table applies to the Brad Nail fasteners to fix the Cemintel cladding directly to support framing (i.e., framing studs or structural noggings) or the Cemintel FC Battens. The minimum structural grade of the timber support framing is MGP10.

NOTE: Brad Nail fasteners are only suitable for buildings satisfying the geometry limitations presented in Australian Standard, AS4055 "Wind loads for housing".

FASTENER ARRANGEMENTS - the Cemintel Edge Cladding and SimpleLine cladding can be fixed to supporting timber framing or Cemintel FC Battens with the following fasteners;

Direct Fix

- ND50 Brad Nail S/S - fix cladding to timber support framing.

Cavity Fix

- C25 Brad Nail S/S - fix cladding to Cemintel FC Battens. Battens are fixed to support framing.

Maximum Stud/Batten Spacing (mm)	Wind Classification	Maximum Brad Nail Fastener Spacing (mm)	
		Cladding Location	
		① General Zones	② Corner Zone
300	N1	250	250
	N2	250	250
	N3/C1	250	250
400 ¹	N1	250	250
	N2	250	250
	N3/C1	250	200
600 ²	N1	250	250 [#]
	N2	250	250 [#]
	N3/C1	250	150 [*]

① GENERAL ZONES -- Wall areas greater than 1200mm from an External Building Corner for Buildings satisfying the AS 4055 geometry limits.

② CORNER ZONES - Wall areas less than 1200mm from an External Building Corner for Buildings satisfying the AS 4055 geometry limits.

NOTE: Loads based on AS 4055 with Factored external pressure coefficient, $k_f C_{pe} = -1.3 \pm 0.7$

Shaded Area - denotes values not applicable to single span (i.e., two supports) Edge or SimpleLine cladding.

1 - Cemintel SimpleLine sheets can be installed on a Maximum Stud/Batten Spacing of 450mm.

2 - Cemintel Edge Cladding sheets only.

- denotes a fastener spacing for fixing Cemintel Edge Cladding Ribbon-Groove and Cemintel Edge Cladding V-Groove sheets, only.

* - denotes a fastener spacing for fixing horizontal installation of Cemintel Edge Cladding products, only.

U.N.O. - denotes unless noted otherwise.

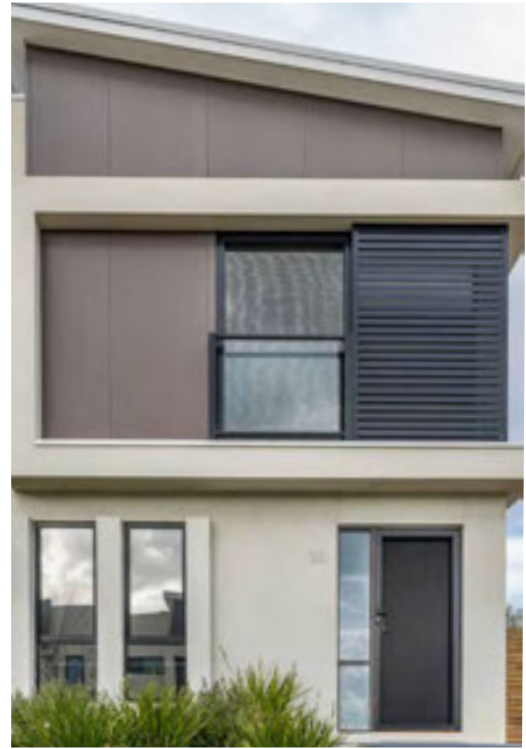
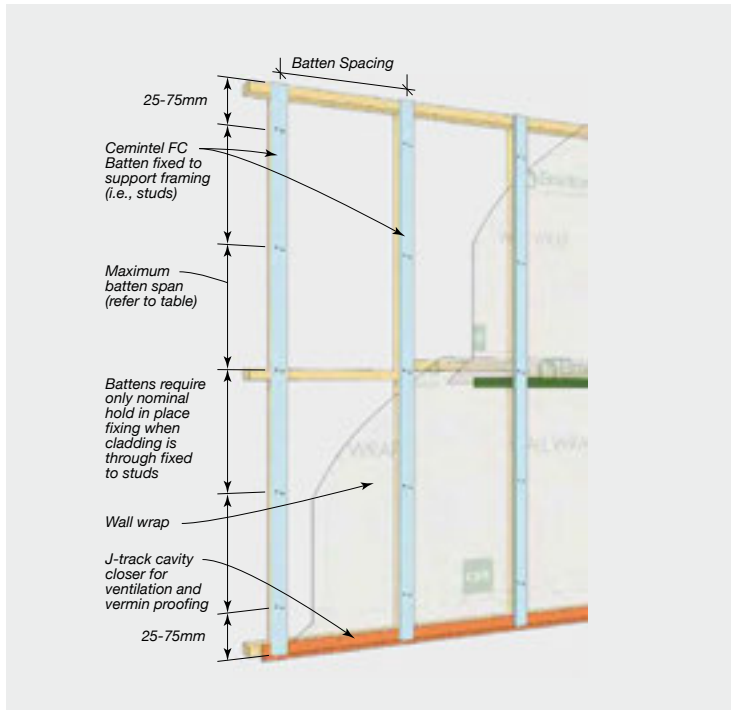
FIGURE 6.04 Typical Cemintel FC Batten Installation**TABLE 6.02** Maximum Span for Fixing Cemintel FC Battens to Framing - AS4055 compliant buildings

NOTE: This table applies to the fasteners to fix the Cemintel FC Batten to support framing when used with Edge and SimpleLine claddings. Provide a double (2) nail or a single screw fixing, U.N.O.. The minimum structural grade of the timber framing is MGPI0 and the minimum steel framing is 0.50mm BMT G550 steel grade and 0.75mm BMT G2 steel grade. The structural capacity of all support frame locations shall be confirmed by the project engineer. The maximum span values are applicable in General Zones and Corner Zones.

FASTENER ARRANGEMENTS - the Cemintel FC Batten can be fixed to support framing (i.e., framing studs or structural noggings) with the following fasteners;

Nail Fix

- 2 - 2.8mmø x 50mm Nails - fix batten to timber support framing.

Screw Fix

- 1 - 8-10 x 57mm Type 17 Screw - fix batten to timber support framing.
- 1 - 8g x 42mm Screw - fix batten to steel support framing.

Maximum Stud/Batten Spacing (mm)	Wind Classification	Maximum Cemintel FC Batten Span (mm)	
		Fastener Arrangements	
		Nail Fix	Screw Fix
300	N1	800	800
	N2	800	800
	N3/C1	600	600
400 ¹	N1	700	700
	N2	650	650
	N3/C1	500	500
600	N1	650	650
	N2	550	550
	N3/C1	400	450

GENERAL ZONES - Wall areas greater than 1200mm from an External Building Corner for Buildings satisfying the AS 4055 geometry limits.

CORNER ZONES - Wall areas less than 1200mm from an External Building Corner for Buildings satisfying the AS 4055 geometry limits.

1 - Cemintel SimpleLine sheets can be installed on a Maximum Stud/Batten Spacing of 450mm.

2 - Cemintel Edge Cladding sheets only.

NOTE: Loads based on AS 4055 with Factored external pressure coefficient, $k_f C_{pe} = -1.3 \pm 0.7$

U.N.O. - denotes unless noted otherwise.

SYSTEM ENGINEERING



Fastener Spacings for Fixing Edge and SimpleLine Cladding

FIGURE 6.05 Fastener Spacing for Fixing Edge and SimpleLine Cladding

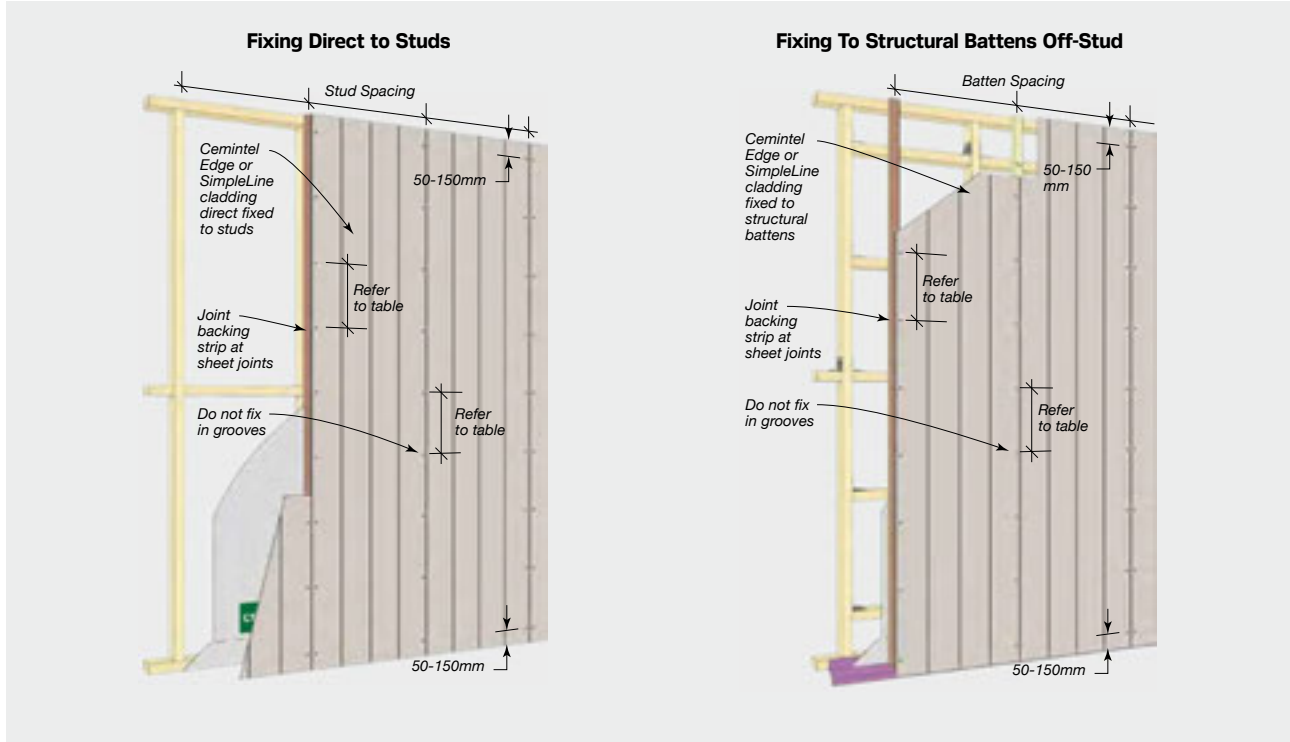



SYSTEM ENGINEERING

TABLE 6.03 Maximum Screw or Nail Fastener Spacing for Fixing Cladding to Support Framing - AS4055 Compliant Buildings

NOTE: All cladding can be single or multiple spans and fixed by 2 or more supports (i.e., framing studs, battens or top-hats) U.N.O..

This table applies to the fasteners to fix the cladding directly to the support framing (i.e., framing studs or structural noggings), through the 18-20mm maximum thickness non-structural battens to the support framing, or directly to the structural timber battens/top hats. The minimum structural grade of the timber framing is MGP10 and the minimum steel framing is 0.50mm BMT G2 steel grade.

The structural timber battens/top hats shall be a minimum 45mm or 70mm wide x 35mm thick MGP10 structural grade timber battens and a minimum 0.75mm BMT G2 steel grade top hats.

When cladding is fixed through the non-structural timber battens and into the structural framing, then battens only require a nominal fixing to hold in-place during the cladding installation.

FASTENER ARRANGEMENTS - the Cemintel Edge Cladding and SimpleLine sheets can be fixed to support framing (i.e., framing studs or structural noggings), structural timber battens, or steel top hats with the following fasteners;

Nail Fix

* 2.5mmø x 50mm Machine Driven Nails - fix cladding to timber support framing.

* 2.5mmø x 45mm Machine Driven Nails - fix cladding to structural timber battens, or timber support framing.

* 2.8mmø x 40mm Hand Driven Clout Nails - fix cladding to structural timber battens, or timber support framing.

* 2.5mmø x 60mm Machine Driven Nails - fix cladding over non-structural timber battens to timber support framing.

* 2.7mmø x 60mm Machine Driven Nails - fix cladding over non-structural timber battens to timber support framing.

Screw Fix

* 10-18 x 30mm FibreTEKS® Screw - fix cladding to steel top hats, or steel support framing.

Maximum Stud/Batten Spacing (mm)	Wind Classification	Maximum Fastener Spacing#,* (mm)	
		Cladding Location	
		① General Zones	② Corner Zone
300	N1	300	300
	N2	300	300
	N3/C1	300	300
	N4/C2	300	275
	N5/C3	300	175
	N6/C4	250	125*
400 ¹	N1	300	300
	N2	300	300
	N3/C1	300	275
	N4/C2	300	175 [#]
	N5/C3	200	125*
	N6/C4	150 [#]	-
600	N1	300	300 [#]
	N2	300	300 [#]
	N3/C1	300*	200*

① GENERAL ZONES – Wall areas greater than 1200mm from an External Building Corner for Buildings satisfying the AS 4055 geometry limits.

② CORNER ZONES – Wall areas less than 1200mm from an External Building Corner for Buildings satisfying the AS 4055 geometry limits.

NOTE: Loads based on AS 4055 with Factored external pressure coefficient, $k_f C_{pe} = -1.3 \pm 0.7$

Shaded Area - denotes values not applicable to single span (i.e., two supports) Edge or SimpleLine cladding.

1 - Cemintel SimpleLine sheets can be installed on a Maximum Stud/Batten Spacing of 450mm.

2 - Cemintel Edge Cladding sheets only.

- denotes a fastener spacing for fixing Cemintel Edge Cladding Ribbon-Groove and Cemintel Edge Cladding V-Groove sheets, only.

* - denotes a fastener spacing for fixing horizontal installation of Cemintel Edge Cladding products, only.

U.N.O. – denotes unless noted otherwise.

SYSTEM ENGINEERING

**TABLE 6.04** Maximum Screw or Nail Fastener Spacing for Fixing Cladding to Support Framing - AS/NZS1170.2

NOTE: All cladding can be single or multiple spans and fixed by 2 or more supports (i.e., framing studs, battens or top-hats) U.N.O..

This table applies to the fasteners to fix the cladding directly to the support framing (i.e., framing studs or structural noggings), through the 18-20mm maximum thickness non-structural battens to the support framing, or directly to the structural timber battens/top hats. The minimum structural grade of the timber framing is MGP10 and the minimum steel framing is 0.50mm BMT G2 steel grade.

The structural timber battens/top hats shall be a minimum 45mm or 70mm wide x 35mm thick MGP10 structural grade timber battens and a minimum 0.75mm BMT G2 steel grade top hats.

When cladding is fixed through the non-structural timber battens and into the structural framing, then battens only require a nominal fixing to hold in-place during the cladding installation.

FASTENER ARRANGEMENTS - the Cemintel Edge Cladding and SimpleLine cladding can be fixed to support framing (i.e., framing studs or structural noggings), structural timber battens, or steel top hats with the following fasteners:

Nail Fix

* 2.5mmØ x 50mm Machine Driven Nails - fix cladding to timber support framing.

* 2.5mmØ x 45mm Machine Driven Nails - fix cladding to structural timber battens, or timber support framing.

* 2.8mmØ x 40mm Hand Driven Clout Nails - fix cladding to structural timber battens, or timber support framing.

* 2.5mmØ x 60mm Machine Driven Nails - fix cladding over non-structural timber battens to timber support framing.

* 2.7mmØ x 60mm Machine Driven Nails - fix cladding over non-structural timber battens to timber support framing.

Screw Fix

* 10-18 x 30mm FibreTEKS® Screw - fix cladding to steel top hats, or steel support framing.

Maximum Stud/Batten Spacing (mm)	Design Ultimate Limit State Pressure (kPa)	Maximum Fastener Spacing#, * (mm)	
		Support Type	
		Timber/Steel	Steel
		(MGP10/0.5mm BMT)	(0.75mm BMT)
300	1.0	300	300
	1.5	300	300
	2.0	300	300
	2.5	300	300
	3.0	250	300
	3.5	225	300
	4.0	200	300
	4.5	175	250
400 ¹	5.0	150	225
	1.0	300	300
	1.5	300	300
	2.0	300 [#]	300 [#]
	2.5	225 [#]	300 [#]
	3.0	200 [#]	300 [#]
600	3.5	125 [*]	225 [*]
	1.0	300 [#]	300 [#]
	1.5	275 [*]	300 [*]
	2.0	-	-

NOTE: **Shaded Area** - denotes values not applicable to single span (i.e., two supports) Edge or SimpleLine cladding.

1 - Cemintel SimpleLine sheets can be installed on a Maximum Stud/Batten Spacing of 450mm.

2 - Cemintel Edge Cladding sheets only.

- denotes a fastener spacing for fixing Cemintel Edge Cladding Ribbon-Groove and Cemintel Edge Cladding V-Groove sheets, only.

* - denotes a fastener spacing for fixing HORIZONTAL installation of Cemintel Edge Cladding products, only.

U.N.O. - denotes unless noted otherwise.

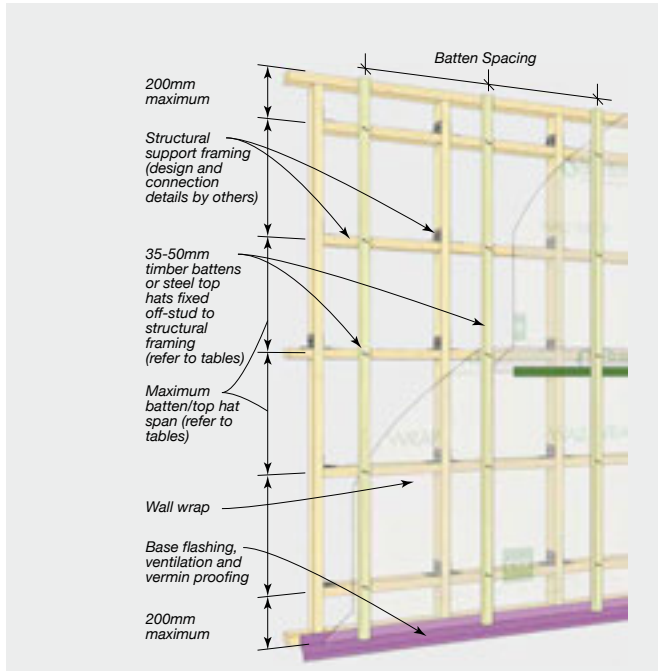
FIGURE 6.06 Typical Timber Batten Installation

SYSTEM ENGINEERING

**TABLE 6.05** Maximum Span for Fixing Battens and Top Hats to Framing - AS4055 compliant buildings

NOTE: The structural timber battens and top hats must be 2 or more spans (i.e., 3 or more supports) and adjacent span lengths must be within 10% of each other.

This table applies to the fasteners to fix the structural timber battens (45mm/70mm wide x 35mm thick MGP10 minimum timber battens) and steel top hats (35mm deep x 0.75mm BMT) to support framing. For structural timber batten connections, provide a double (2) nail or a single screw fixing, U.N.O.. The minimum structural grade of the timber framing is MGP10 and the minimum steel framing is 0.50mm BMT. The structural capacity of all support locations to be confirmed by the project engineer.

Type A and Type B Construction buildings must use steel frames and Intermediate Top Hats only. Type C Construction buildings may use either timber / steel frames, battens, or steel top hats.

FASTENER ARRANGEMENTS - the structural timber battens and top hats can be fixed to support framing (i.e., framing studs or structural noggings) with the following fasteners;

Nail Fix

- 3.75mmØ x 75mm Hand Driven Flat Head Nails - fix batten to timber support framing. * Maximum hand driven double nail spacing is 600mm.
- 3.15mmØ x 90mm Machine Driven Nails - fix batten to timber support framing.

Screw Fix

- 10-16 x 55mm Screw - fix batten to steel support framing.
- 10-16 x 40mm Screw - fix batten to steel support framing.
- 12-11 x 45mm Type 17 Screw - fix top hat to timber support framing.
- 10-14 x 20mm Screw - fix top hat to steel support framing.

Maximum Batten/Top Hat Spacing (mm)	Wind Classification	Maximum Structural Batten/Top Hat Span (mm)			
		Batten/Top Hat Type and Cladding Location			
		Timber Batten*		Steel Top Hat	
		① General Zone	② Corner Zone	① General Zone	② Corner Zone
300	N1	1850	1000	2650	1450
	N2	1850	1000	2650	1450
	N3/C1	1200	650	1700	900
	N4/C2	800	400	1150	600
	N5/C3	550	250	750	400
	N6/C4	-	-	-	-
400	N1	1250	650	1750	950
	N2	1250	650	1750	950
	N3/C1	800	400	1150	600
	N4/C2	500	250	750	400
	N5/C3	-	-	-	-
	N6/C4	-	-	-	-
600	N1	1300	700	1850	1000
	N2	900	500	1350	700
	N3/C1	600	300	850	450
	N4/C2	-	-	-	-
	N5/C3	-	-	-	-
	N6/C4	-	-	-	-

① GENERAL ZONES – Wall areas greater than 1200mm from an External Building Corner for Buildings satisfying the AS 4055 geometry limits.

② CORNER ZONES – Wall areas less than 1200mm from an External Building Corner for Buildings satisfying the AS 4055 geometry limits.

NOTE: Loads based on AS/NZS 1170.2 with factored external pressure coefficient $k_1 C_{pe} = -1.3 \pm 0.7$

Shaded Area - denotes a 600mm maximum batten span where battens are to be hand nailed.

U.N.O. - denotes unless noted otherwise.



SYSTEM ENGINEERING

TABLE 6.06 Maximum Span for Fixing Battens and Top Hats to Framing - AS/NZS1170.2

NOTE: The structural timber battens and top hats must be 2 or more spans (i.e., 3 or more supports) and adjacent span lengths must be within 10% of each other.

This table applies to the fasteners to fix the structural timber battens (45mm/70mm wide x 35mm thick MGP10 minimum timber battens) and steel top hats (35mm deep x 0.75mm BMT) to support framing. For structural timber batten connections, provide a double (2) nail or a single screw fixing, U.N.O.. The minimum structural grade of the timber framing is MGP10 and the minimum steel framing is 0.50mm BMT. The structural capacity of all support locations to be confirmed by the project engineer.

Type A and Type B Construction buildings must use steel frames and Intermediate Top Hats only. Type C Construction buildings may use either timber / steel frames, battens, or steel top hats.

FASTENER ARRANGEMENTS - the structural timber battens and top hats can be fixed to support framing (i.e., framing studs or structural noggings) with the following fasteners:

Nail Fix

- 3.75mmØ x 75mm Hand Driven Flat Head Nails - fix batten to timber support framing. * Maximum hand driven double nail spacing is 600mm.
- 3.15mmØ x 90mm Machine Driven Nails - fix batten to timber support framing.

Screw Fix

- 10-16 x 55mm Screw - fix batten to steel support framing.
- 10-16 x 40mm Screw - fix batten to steel support framing.
- 12-11 x 45mm Type 17 Screw - fix top hat to timber support framing.
- 10-14 x 20mm Screw - fix top hat to steel support framing.

Maximum Batten/Top Hat Spacing (mm)	Design Ultimate Limit State Pressure (kPa)	Maximum Structural Batten/Top Hat Span (mm)			
		Batten/Top Hat Type and Framing Type			
		Timber Batten*		Steel Top Hat	
		Timber	Steel	Timber	Steel
300	1.0	1650	1250	3150	3150
	1.5	1100	800	1850	1200
	2.0	800	600	1550	900
	2.5	650	500	1350	700
	3.0	550	400	1200	600
	3.5	450	350	1100	500
	4.0	400	300	1000	450
	4.5	350	250	900	400
	5.0	300	250	850	350
400/450	1.0	1100	800	2700	2400
	1.5	700	550	1450	800
	2.0	550	400	1200	600
	2.5	400	300	1050	450
	3.0	350	250	900	400
	3.5	300	200	850	300
600	1.0	800	600	2350	1800
	1.5	550	400	1200	600
	2.0	400	300	1000	450

NOTE: **Shaded Area** - denotes a 600mm maximum batten span where battens are to be hand nailed.
U.N.O. - denotes unless noted otherwise.

CHECKLIST – Prior to Installation

The following pre-install checklist may assist with ensuring you have the best possible outcome when installing the Edge and SimpleLine cladding.

- Ensure substrate is structurally sound and square. Edge and SimpleLine cladding cannot compensate for excessively misaligned framing and may show an uneven surface even after the coating has been applied. Cemintel recommends that alignment should be within 4mm over 3000mm, 3mm over 1200mm, or 2mm over 600mm when checked both horizontally and vertically. Pack to straighten if necessary (timber frames as per AS 1684, steel frames as per AS/NZS4600). **Check with certifier or building certifier regarding packing materials.**
- Confirm bracing is in place. Where sheet bracing is used behind sheets, the entire wall area needs to be braced or bracing sheet packers fixed to the frame to ensure a uniform fixing plane.
- Ensure studs and noggings are correctly located and of the appropriate width (Refer to “Design + Aesthetic Considerations” and tables in “System Engineering” section). Timber and steel studs must have a minimum fixing face width of 35mm and be spaced at maximum 600mm centres to ensure they match sheet widths and fixing locations. All sheet edges must be supported by framing members. Ensure all noggings are flush.
- Install additional studs, trimmers and noggings to support sheet edges, battens and top hats, prior to installation of the wall wrap.
- Install additional studs at control joints.
- Remove any concrete that may foul the cladding line, particularly at steps in slabs and isolated columns.
- Ensure there is adequate ground clearance to the bottom edge of the Edge and SimpleLine cladding, as per regulatory requirements (including for water/rain runoff and termite management). These can vary from 20-150mm depending on type of ground and termite requirements.
- Confirm your panel layout to determine the location of joints and identify whether additional studs are required.
- Confirm the chosen eaves and soffit details and prepare accordingly. Ensure cavity blocking has been installed in the stud, roof and floor framing.
- Arrange for a pre-cladding inspection by the appropriate local building authority if required.



Check quality and quantity of sheets and components before installing. If there is any sign of damage or visible defects in sheets, or the colour/finish is not in keeping with the owners' aesthetic requirements DO NOT INSTALL. Contact Cemintel to address any issues.



07

INSTALLATION

Installation Considerations

Fastener Placement

Sheets are fixed to the batten, top hat or framing using nails or screws. Refer to 'Construction Drawings + Details' section for appropriate fixing information for the chosen fasteners.

Fasteners are to be spaced as detailed in Table 6.04 and Table 6.05. Fasteners must be positioned at a minimum 18mm U.N.O. from sheet edges, 50mm – 150mm from sheet corners, in the full sheet thickness only and not in a groove, and 25mm minimum from the batten end. The batten fasteners must be 200mm minimum from batten ends. Fastener heads must be driven flush with the sheet surface.

FIGURE 7.01 Sheet Layout Around Small Openings

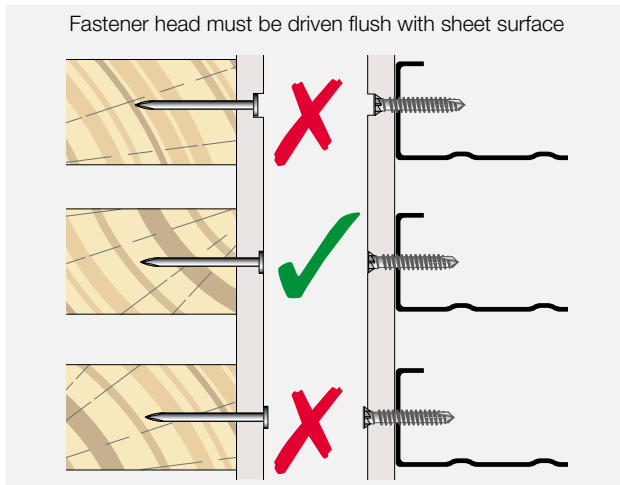
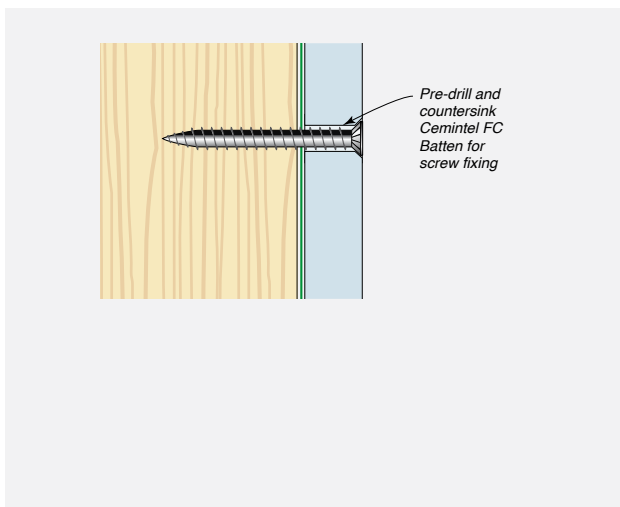

FIGURE 7.02 Pre-drill Batten for Screw Fixing



Batten/Top Hat Installation

Battens and top hats may be installed On-stud or Off-stud, provided suitably designed framing supports are installed behind each fixing location. For screw fixing, the CeminTEL FC Batten, the battens must be pre-drilled and countersunk. Nails are to be used in pairs, spaced 30mm to 100mm apart.

Penetrations

Penetrations in cladding sheets may be cut or drilled prior to installation. Cut from the back or drill from the front. Cut penetrations oversize by 6 – 10mm all round. Mask, prime and fill gaps with sealant in accordance with recommended methods and products.

FIGURE 7.03 Batten Joining – On-Stud Only

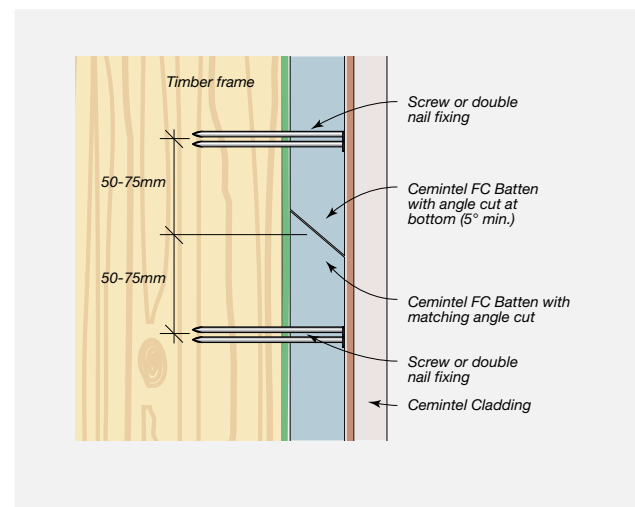

INSTALLATION

07

Hole Forming

Small holes are formed by using a Hole Saw:

1. Locate the centre of the hole.
2. Form hole with appropriately sized hole saw.

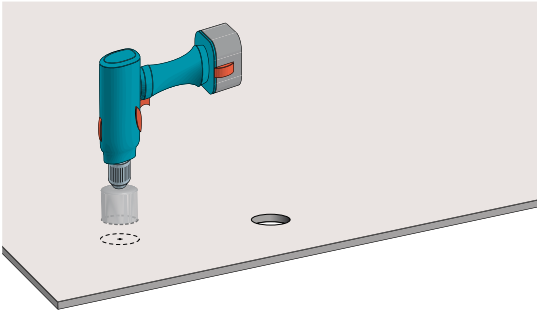

Large holes or openings are formed by using a Jig Saw fitted with a masonry blade:

1. Mark the required opening.
2. Drill holes in all corners using high speed masonry drill and do not use the hammer action.
3. Cut along marked lines.

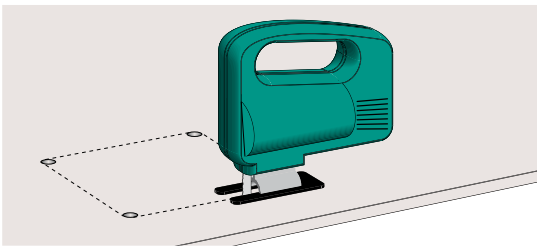
**Flashings & Cappings**

In general, flashings shall be designed and installed in accordance with SAA-HB39 1997 - Installation code for metal roofing and wall cladding. All flashings are supplied by others.

Base Details

Flashing sheets must overhang footings and must be kept clear of the ground. Refer to base details in “Construction Drawings + Details”.

In addition to regulatory requirements (i.e., termite risk management, surface water drainage, etc.), Cemintel requires cladding clearances of:

- 20mm minimum to a paved surface; and
- 100mm minimum to an unpaved surface.

Cavity Flashing / J-Track

The cavity flashing and J-track provide a barrier to vermin and drafts from the cavity, while allowing moisture to freely escape.

At corners of the building, the flashing must be mitred and/or sealed to prevent wind and water from being driven behind the sheeting, refer to Figure 7.04 and Figure 7.05.

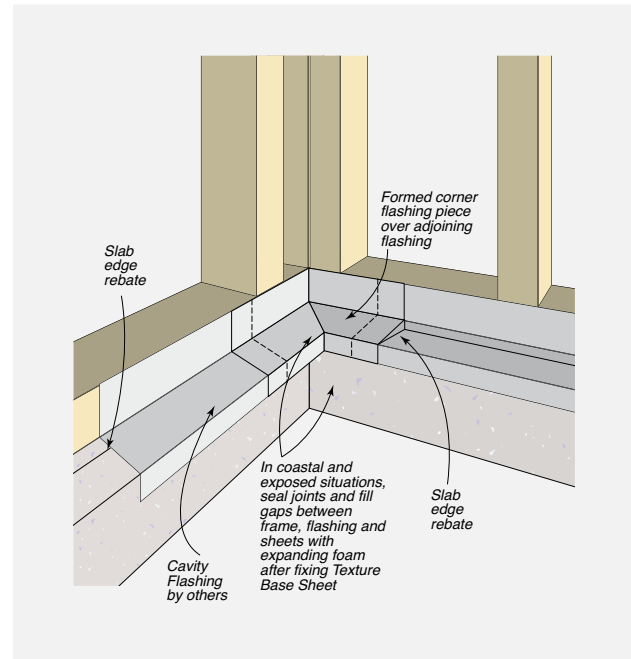
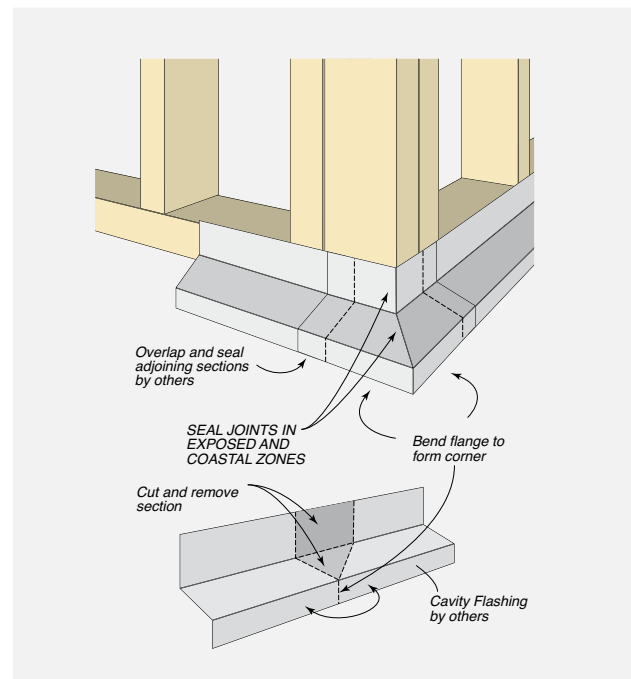
FIGURE 7.04 Base Flashing at Internal Corner**FIGURE 7.05** Base Flashing at External Corner**Corner Details**

Internal and external corners are to have PVC or metal flashing installed over wall wrap/sarking for additional water resistance. Refer to Corner Details in “Construction Drawings + Details”.

07

INSTALLATION

Structural Support Framing – Cavity Fix System

Timber or steel stud framing is to be designed in accordance with the relevant standards, and maximum stud spacing is to be as shown in the design tables in ‘Systems Engineering’ section. The Edge and SimpleLine cladding is installed vertically on battens or top hats. Joints not aligned with studs require an Off-stud batten, as shown in Figures 7.07 and 7.08, fixed to structural stud framing / nogging.

Double studs are required at the sides of openings and additional studs should be installed at internal corners as shown in the ‘Construction Drawings + Details’ section.

Timber battens are to be fixed to each stud and/or structural nogging with screws or nails spaced at 200mm maximum from their ends and at spacings as shown in Figures 6.04 and 6.06.

Battens must also be provided at the sides of openings for support and fixing of head reveals. Where vertical sheet joints are formed between studs, a batten or top hat is required behind the joint, see Figures 7.07 to 7.08. The battens or top hats must be supported by horizontal support framing spaced as shown in the design tables in ‘Systems Engineering’ section.

FIGURE 7.06 On-stud Fixing of Timber Batten to Stud

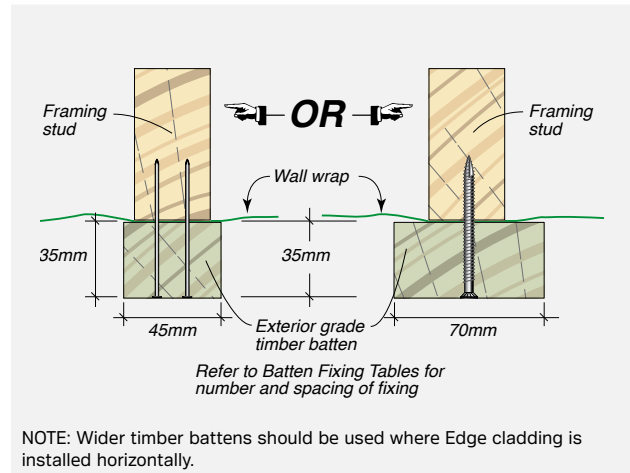

FIGURE 7.07 Off-stud Sheet Joint Location (NOTE: Design of off-stud batten support framing is the responsibility of the frame designer)

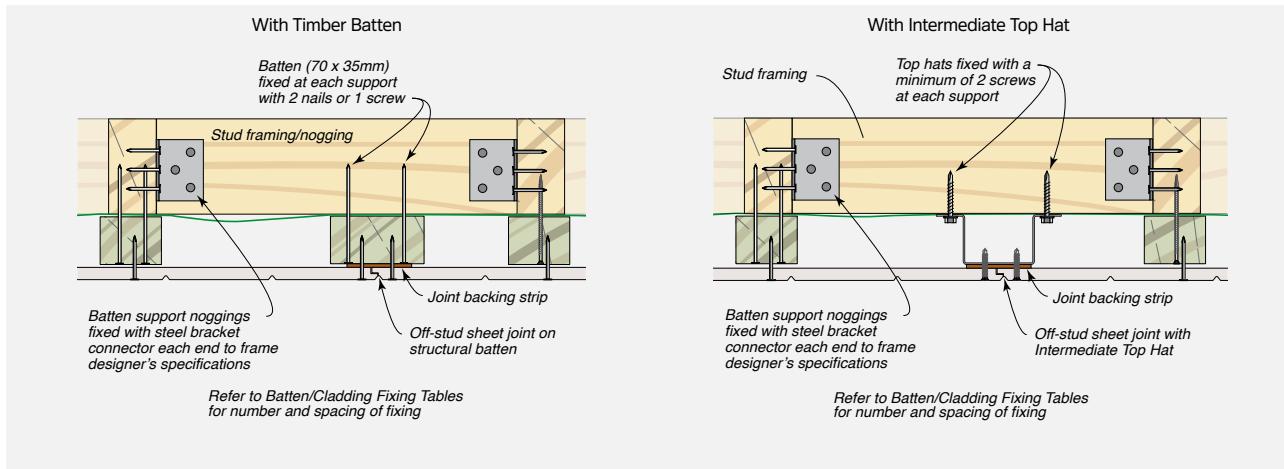
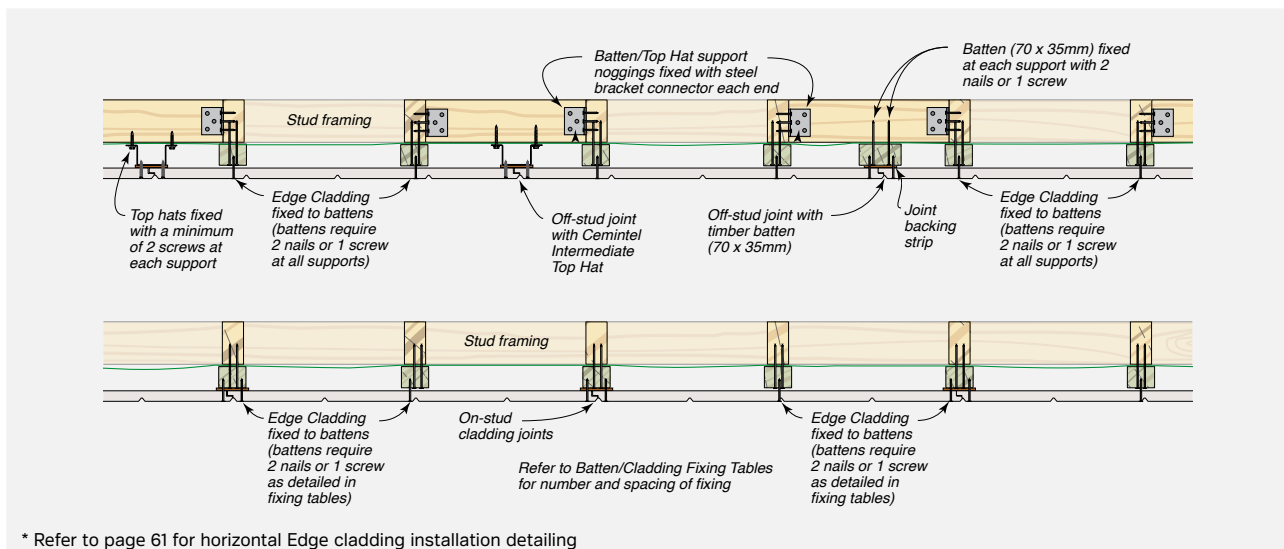

FIGURE 7.08 Sheet Joint Location & Support (NOTE: Design of off-stud batten support framing is the responsibility of the frame designer)



* Refer to page 61 for horizontal Edge cladding installation detailing

Installation of Wall Wrap

Whilst the requirement to seal joins and penetrations of the wall wrap may vary depending upon BCA and/or state requirements, CSR recommends sealing the external wall wrap/sarking to maintain vapour, and draught control effectiveness, as well as to ensure water barrier integrity. If the membrane is used to provide a continuous air tight layer, all overlaps should be sealed, and membrane installed in accordance with the construction detailing in the Cemintel Air Barriers Design Guide.

FIGURE 7.09 Typical Double Layer Wall Wrap Over Openings – Direct Fix System

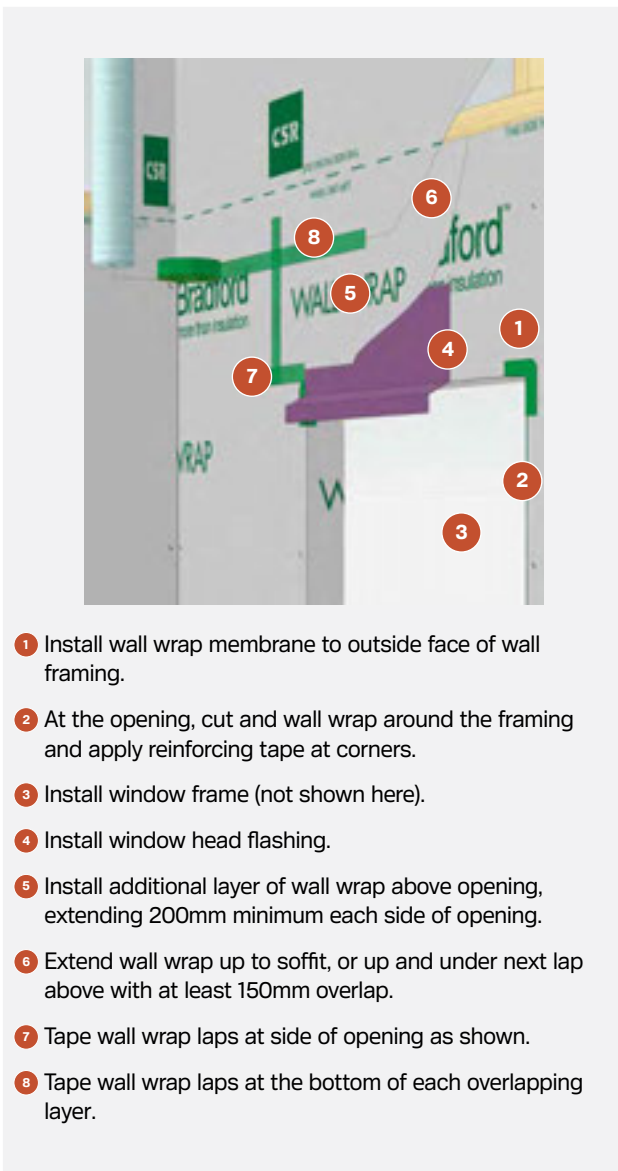
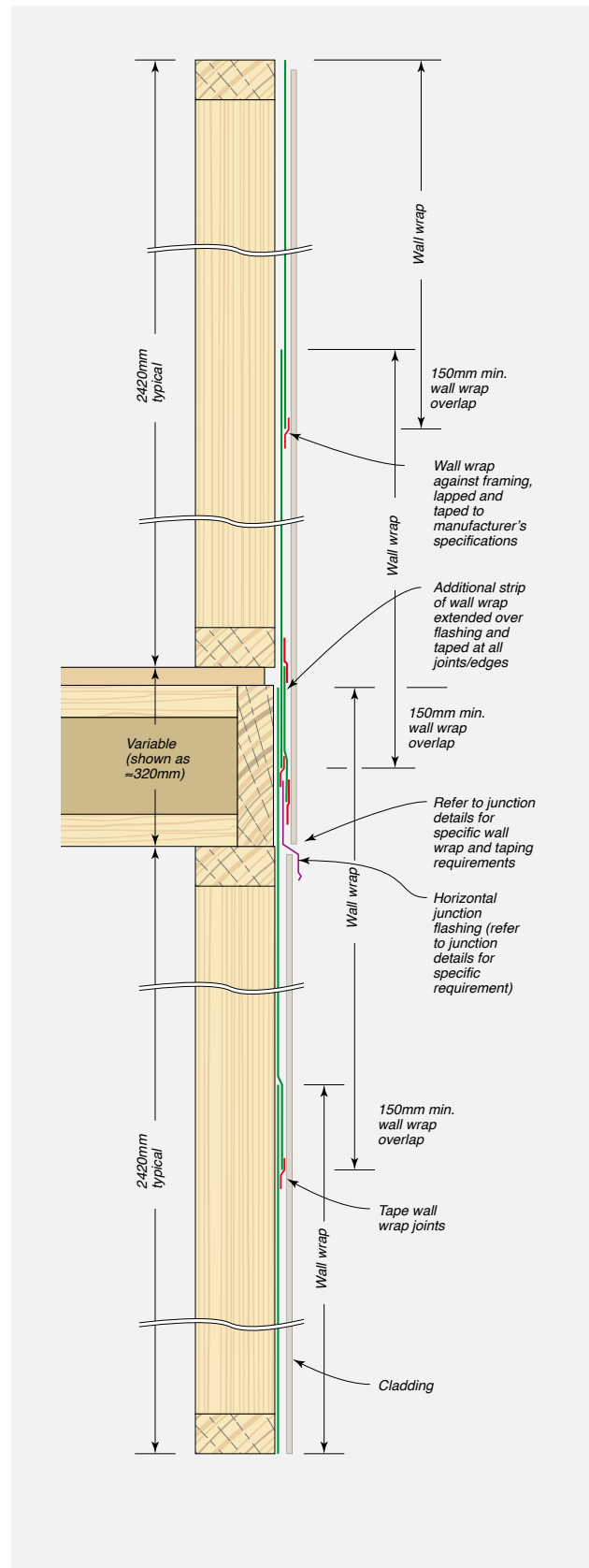

FIGURE 7.10 Typical Wall Wrap Layout for Two-Storey Framing



07

INSTALLATION

FIGURE 7.11 Typical Wall Wrap Installation

- 1 Install wall wrap/sarking membrane to outside face of wall framing. Temporary fixing of wall wrap to framing may be by double sided tapes or other approved methods. Refer to the wall wrap manufacturer's specifications.
- 2 Vertical laps (including corners) should overlap by one stud spacing minimum and should be staggered between adjacent layers.
- 3 Upper layers should overlap lower layers by 150mm minimum to ensure that water is always shed towards the outside of the membrane and building.
- 4 Horizontal flashings such as at the head of doors and windows, horizontal storey junctions and at the wall base (when used) require special treatment to ensure water is always shed towards the outside. Refer to appropriate junction details for specific requirements.
- 5 At openings, slit the wall wrap at 45 degrees from each corner to the centreline. Slit the centreline to open the wrap.
- 6 Wrap the tabs around the framing.
- 7 Pull wall wrap/sarking triangular pieces through opening of frame. Staple 10-15mm inwards from the inner face of the framing edge at 300mm maximum centres. Trim wall wrap/sarking 5mm short from inner edge of frame opening.
- 8 Apply Enviroseal ProctorWrap tape to the corners of openings.
- 9 Wipe tape over the frame edge onto the face of the wall wrap.

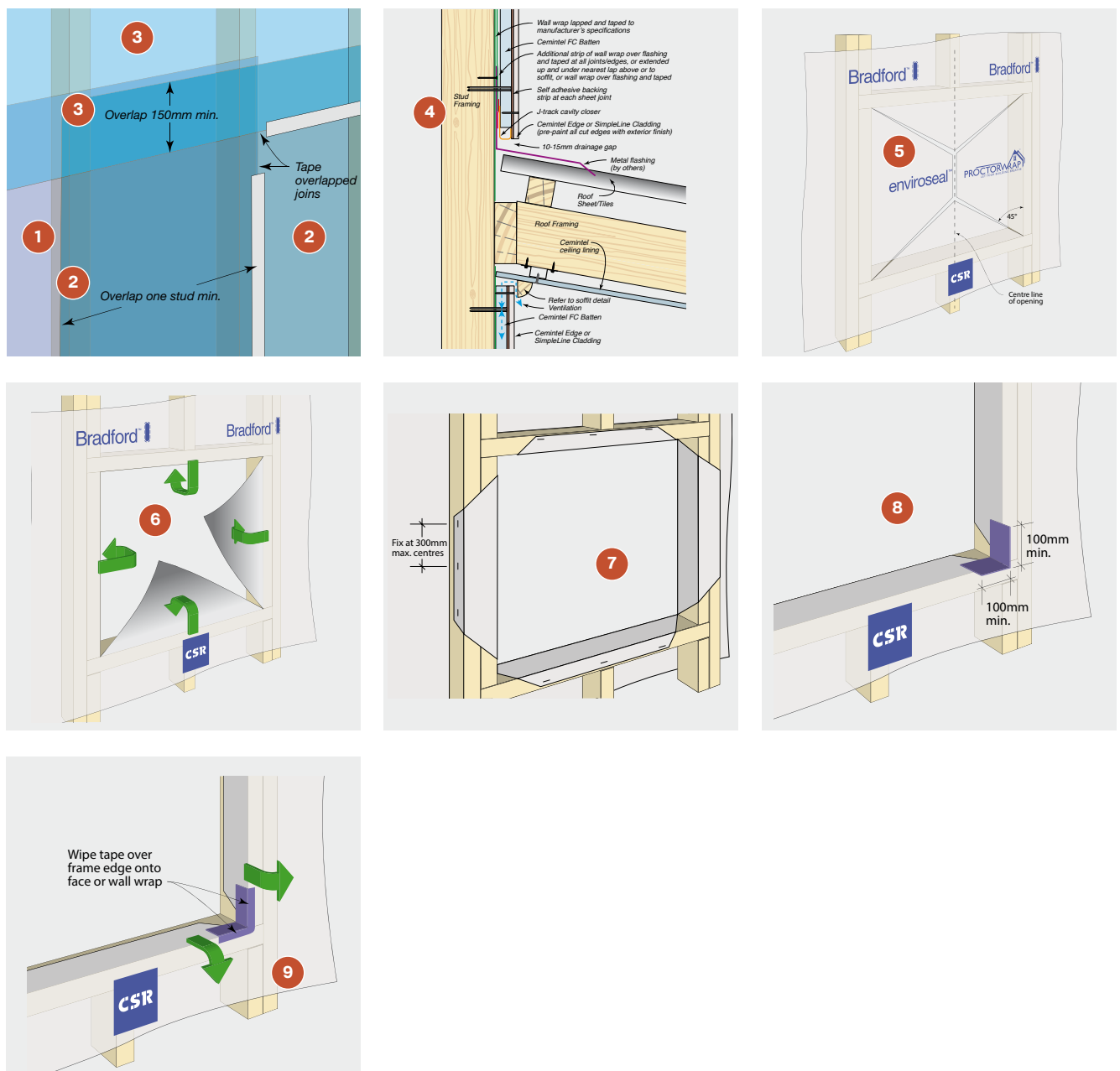

INSTALLATION

07

Edge Cladding + SimpleLine – Direct Fix System**Installation CHECKLIST – Direct Fix System**

- All joints must be supported by a framing member, and all edges must be supported at openings and perimeters. Add extra framing members as required.
- Correct set-out of the framework can minimise the amount of additional framing at the sheet joints.
- For narrow studs (steel and timber face widths less than 45mm) at cladding joints provide an additional stud or trimmer to achieve the minimum support width.
- Sheets must not be fastened directly to hot rolled steel sections or purlin/girt sections, as this may result in joint failure. Refer to “Design + Aesthetic Considerations” section.
- For steel framing, add a thermal break to all framing and battens that support the cladding sheets.
- Control Joints are to be constructed with double studs to allow for expansion and contraction of the framing and the cladding.
- IMPORTANT** – The joint configuration must be confirmed with the coating system manufacturer/installer prior to sheet installation.

Once wind loads have been determined, fastener type and spacings for the cladding fixing details may be selected from the appropriate tables in the “System Engineering” section of this guide.

Installation PROCEDURE – Direct Fix System

- 1 Ensure framing is installed and aligned to system specifications.
- 2 Install wall wrap. Refer to flashing requirements.
- 3 Prepare corner details to chosen specification.
- 4 Prepare head and base details to chosen specification.
- 5 Install backing strip tape to wall wrap at sheet joints.
- 6 Fix Edge and SimpleLine cladding sheets to system specifications.
- 7 Apply a bead of sealant down the ship-lap edge of each sheet join..
- 8 Install additional sheets, following the installation sequence.
- 9 Complete corner, head and soffit installation as per chosen details.
- 10 Prepare and apply external finish as per specification requirements.



07

INSTALLATION

Edge Cladding + SimpleLine – Cavity Fix System**Installation CHECKLIST – Cavity Fix System**

- All joints must be supported by a framing member. Vertical joints between sheets must always coincide with a supporting batten.
- Edge Cladding can be oriented vertically or horizontally.
- SimpleLine cladding to be oriented vertically.
- Install vertical timber or fibre cement battens, or steel top hats to structural support framing (i.e., studs and structural noggings) where required for sheet fixing (Refer to tables in “System Engineering” section for fastener centres).
- Battens to be fixed with the specified fasteners. For off-stud batten/top hat locations suitably designed framing supports must be provided behind each fixing point of the batten.
- Install additional battens to support the free edges. Ensure adequate drainage is provided at horizontal surfaces to prevent moisture ponding.
- Continue with Edge and SimpleLine cladding installation as for direct fix system details for fixing the Edge and SimpleLine cladding.
- Refer to the “Systems Engineering” section for screw spacing information.

Once wind loads have been determined, fastener type and spacings for the batten and cladding fixing details may be selected from the appropriate tables in the “System Engineering” section of this guide.

Installation PROCEDURE – Cavity Fix System

- 1 Ensure framing is installed and aligned to system specifications and appropriate framing is in-place to accept on-stud and/or off-stud battens.
- 2 Install wall wrap. Refer to flashing requirements.
- 3 Install J-Track at the base of the cavity.
- 4 Install non-structural battens to the face of studs, or structural battens/top hats to structural framing.
- 5 Prepare corner details to chosen specification.
- 6 Prepare head detail to chosen specification.
- 7 Install backing strip tape to battens at sheet joints.
- 8 Fix Edge and SimpleLine cladding sheets to system specifications.
- 9 Apply a bead of sealant down the ship-lap edge of each sheet joint.
- 10 Install additional sheets, following the installation sequence.
- 11 Complete corner, head and soffit details as required.
- 12 Prepare and apply external finish as per specification requirements.



INSTALLER'S CHECKLIST



The following checklist can assist in making the Cemintel Edge and SimpleLine installation process run smoothly.

ACTION	COMPLETED	ACTION	COMPLETED
Pre-Cladding Checklist		Post-Cladding Checklist	
1	Confirm that studs are located in accordance with project specifications.	1	Confirm all appropriate joints have been neatly filled with recommended sealant.
2	Confirm additional framing is appropriately located for fixing of off-stud battens when used.	2	Confirm all fastener heads have been finished flush with the surface.
3	Confirm timber framing alignment is in accordance with AS1684, or steel framing is in accordance with AS/NZS4600, and correct if necessary.	3	Confirm sealant has been applied to gaps at openings (where appropriate).
4	Confirm bracing is in place.	4	Confirm all trims at corners and soffit have been completed correctly.
5	Confirm ground clearance to the bottom of the Edge and SimpleLine sheets will be in accordance with Australian Standards and Cemintel requirements of minimum 20mm to paved surface or 100mm to unpaved surface.	5	Confirm appropriate painting of cladding and all exposed edges.
6	Confirm that the wall wrap/sarking has been fully and correctly installed, and overlapped and taped at joints and flashings.		
7	Confirm windows are front draining type.		
8	Confirm all window and door flashings are correctly installed and taped where appropriate.		
9	Confirm that window placement/reveal depth provides the appropriate clearance for board installation.		
10	Confirm adequate structural support for fixtures such as pergolas and decks has been provided. No loads may be carried by the cladding.		
11	Confirm membranes and flashings for deck areas have been installed in accordance with manufacturer's specifications.		
12	CAVITY FIX WALL SYSTEMS – Confirm batten spacing and fixing methods.		
13	Arrange for a pre-cladding inspection by the appropriate local building authority.		



CONSTRUCTION DRAWINGS AND DETAILS

Edge Cladding + SimpleLine Vertical Installation – Direct Fix System

SECTION	DESCRIPTION	FIGURE REFERENCE	PAGE NUMBER
DIRECT FIX			
General Details	Typical Cemintel Edge or SimpleLine Installation – Direct Fixed to Framing	8.01	35
Panel Fixing Details	Typical Nail Fixing Direct to 45mm min. Stud Framing – Edge RIBBON – Groove	8.02	35
	Typical Nail Fixing Direct to Narrow Stud and Trimmer/Double Studs – Edge Ribbon-Groove	8.03	35
	Typical Nail Fixing Direct to 45mm min. Stud – Edge V-Groove	8.04	36
	Typical Nail Fixing Direct to Narrow Stud and Trimmer/Double Studs – Edge V-Groove	8.05	36
	Typical Nail Fixing Direct to 45mm Stud – SimpleLine	8.06	36
	Typical Nail Fixing Direct to Narrow Stud and Trimmer/Double Studs – SimpleLine	8.07	36
	Typical Screw Fixing Direct to Steel Stud and Trimmer/Double Studs – Edge Ribbon-Groove	8.08	37
	Typical Screw Fixing Direct to Steel Stud and Trimmer/Double Studs – Edge V-Groove	8.09	37
	Typical Screw Fixing Direct to Steel Stud and Trimmer/Double Studs – SimpleLine	8.10	37
Base Details	Base – Concrete Slab	8.11	37
	Base – Pier or Stub Wall	8.12	38
Corner Details	External Corner with Sealant	8.13	38
	External Corner with Timber Trim	8.14	38
	External Corner with Two-piece Aluminium Corner	8.15	38
	Obtuse Angle Corner Detail – With Metal Flashing – Direct Fixed Sheets	8.16	39
	Internal Corner with Sealant	8.17	39
	Internal Corner with Timber Trim	8.18	39
	Internal Corner with Two-piece Aluminium Corner	8.19	39
Eaves/Soffit Details	Soffit Detail	8.20	40
	Head Detail – Eaves	8.21	40
Horizontal Junctions	Second Storey Horizontal Junction	8.22	40
	Typical Second Storey Junction with Hebel Panels, Brick Veneer or Masonry Wall – Cantilevered Framing	8.23	40
	Typical Second Storey Junction with Hebel Panels, Brick Veneer or Masonry – In-line Framing	8.24	41
Vertical Junctions	Junction of Edge Cladding System with Alternative Fibre Cement Cladding – Plan View	8.25	41
	Junction of Edge Cladding System with Offset or In-line Masonry Wall – Plan View	8.26	41
	Junction of Cladding with External Parallel Roofing	8.27	41
	Junction of Cladding with External Perpendicular Roofing	8.28	42
Parapet Details	Horizontal Parapet – Elevation	8.29	42
Window/Door Details	Typical Window Installation	8.30	43
	Typical Sliding Door Installation – 70mm Framing Shown	8.31	43
Meter Box Details	Typical Power Meter Box – Recessed Installation	8.32	44
	Typical Power Meter Box – Face Mounted Installation	8.33	45
Fire Details	Typical Edge Cladding Fire Rated Direct Fix Wall System Layout	8.34	46

CONSTRUCTION DRAWINGS AND DETAILS



Edge Cladding + SimpleLine Vertical Installation – Direct Fix System

FIGURE 8.01 Typical Cemintel Edge or SimpleLine Installation – Direct Fixed to Framing

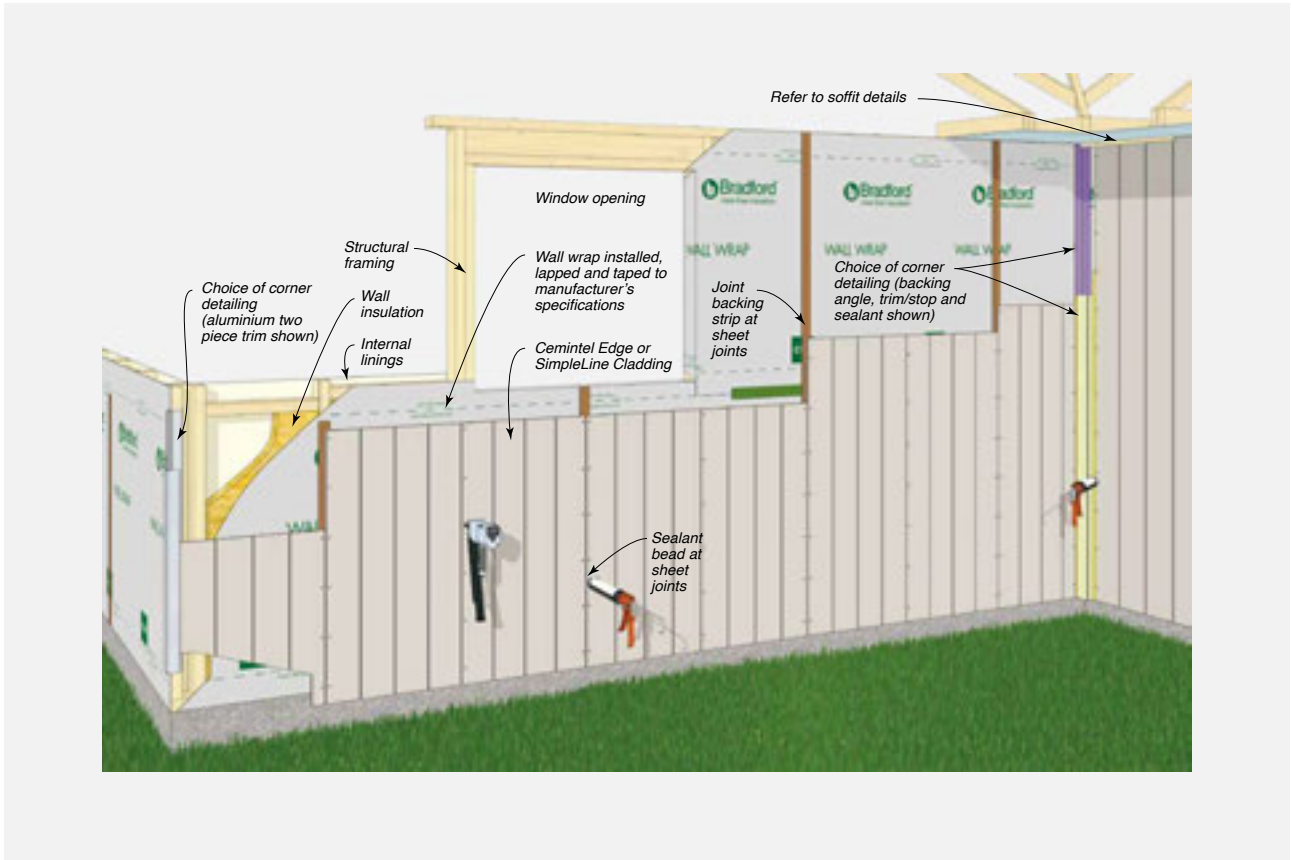

FIGURE 8.02 Typical Nail Fixing Direct to 45mm min. Stud Framing – Edge Ribbon-Groove

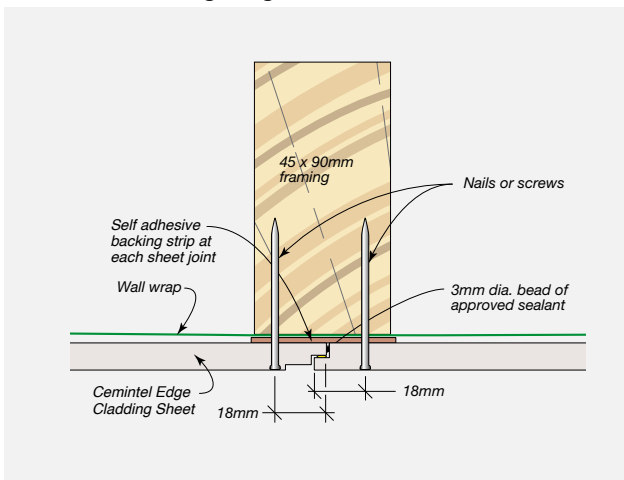
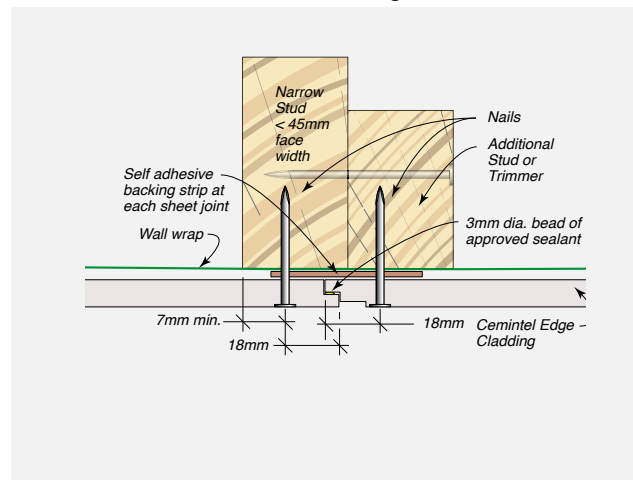

FIGURE 8.03 Typical Nail Fixing Direct to Narrow Stud and Trimmer/Double Studs – Edge Ribbon-Groove





CONSTRUCTION DRAWINGS AND DETAILS

Edge Cladding + SimpleLine Vertical Installation – Direct Fix System

FIGURE 8.04 Typical Nail Fixing Direct to 45mm min. Stud – Edge V-Groove

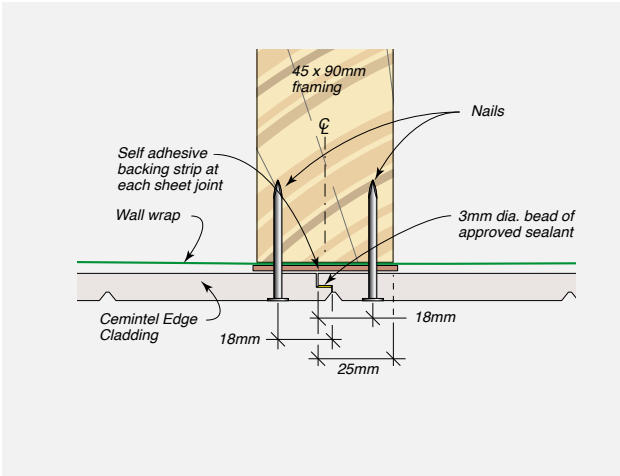

FIGURE 8.05 Typical Nail Fixing Direct to Narrow Stud and Trimmer/Double Studs – Edge V-Groove

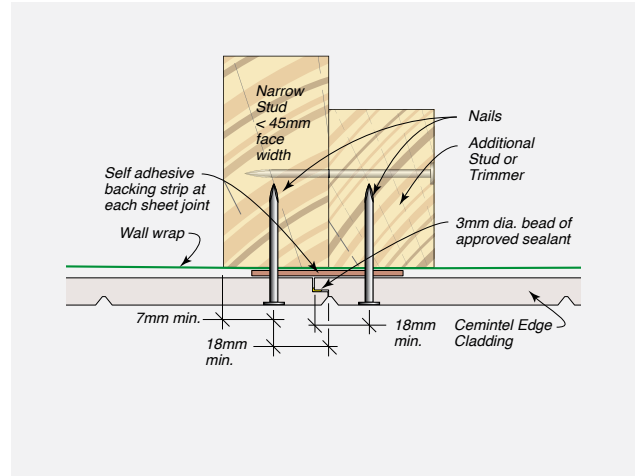

FIGURE 8.06 Typical Nail Fixing Direct to 45mm Stud – SimpleLine

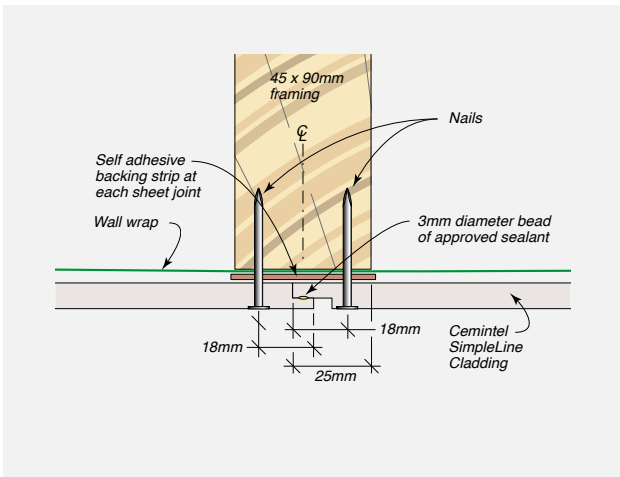
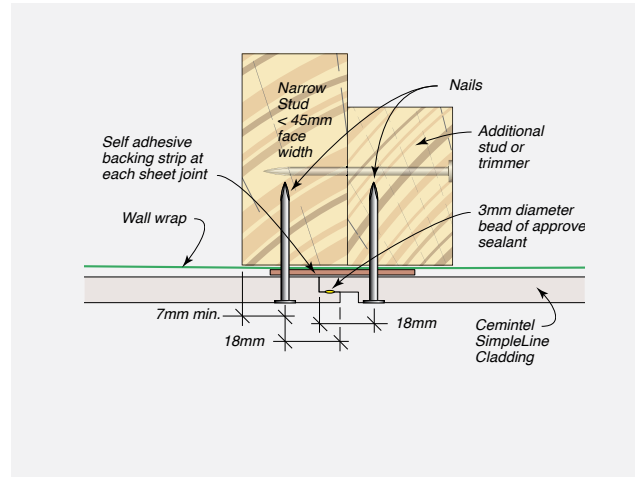

FIGURE 8.07 Typical Nail Fixing Direct to Narrow Stud and Trimmer/Double Studs – SimpleLine



CONSTRUCTION DRAWINGS AND DETAILS



Edge Cladding + SimpleLine Vertical Installation – Direct Fix System

FIGURE 8.08 Typical Screw Fixing Direct to Steel Stud and Trimmer/Double Studs – Edge Ribbon-Groove

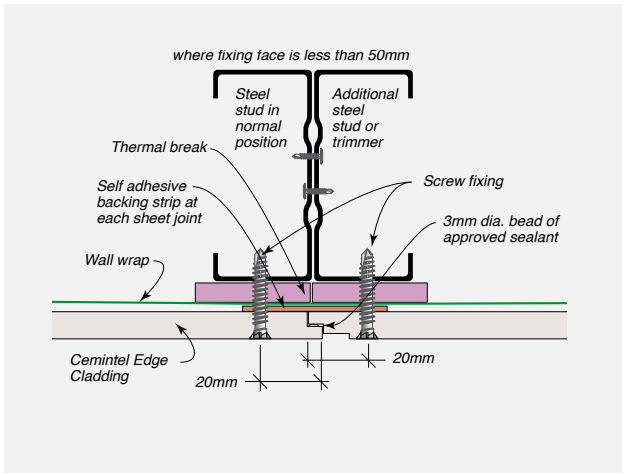

FIGURE 8.09 Typical Screw Fixing Direct to Steel Stud and Trimmer/Double Studs – Edge V-Groove

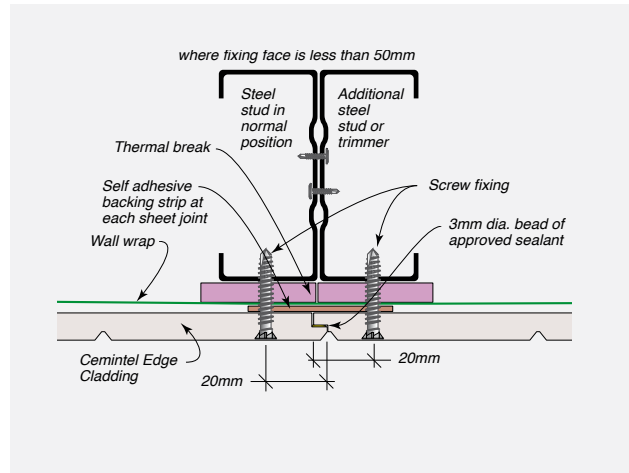

FIGURE 8.10 Typical Screw Fixing Direct to Steel Stud and Trimmer/Double Studs – SimpleLine

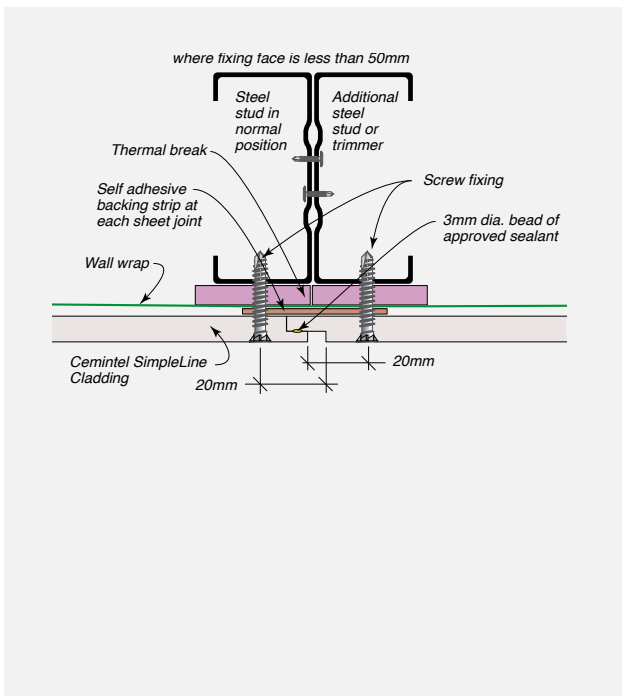
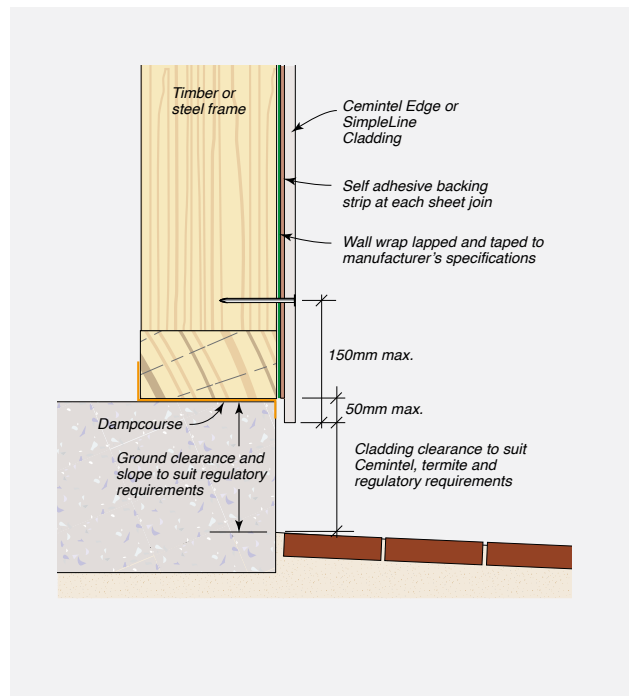

FIGURE 8.11 Base – Concrete Slab





CONSTRUCTION DRAWINGS AND DETAILS

Edge Cladding + SimpleLine Vertical Installation – Direct Fix System

FIGURE 8.12 Base – Pier or Stub Wall

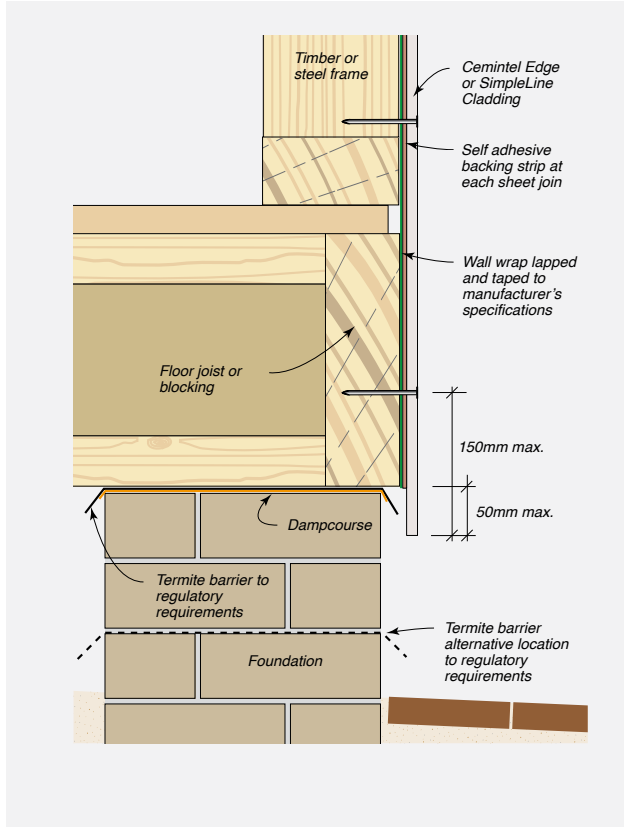

FIGURE 8.13 External Corner with Sealant

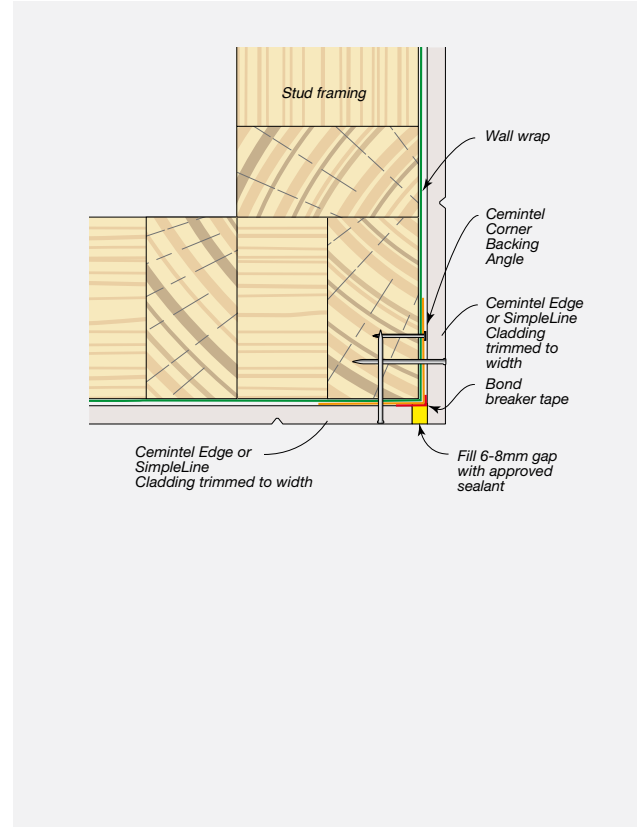

FIGURE 8.14 External Corner with Timber Trim

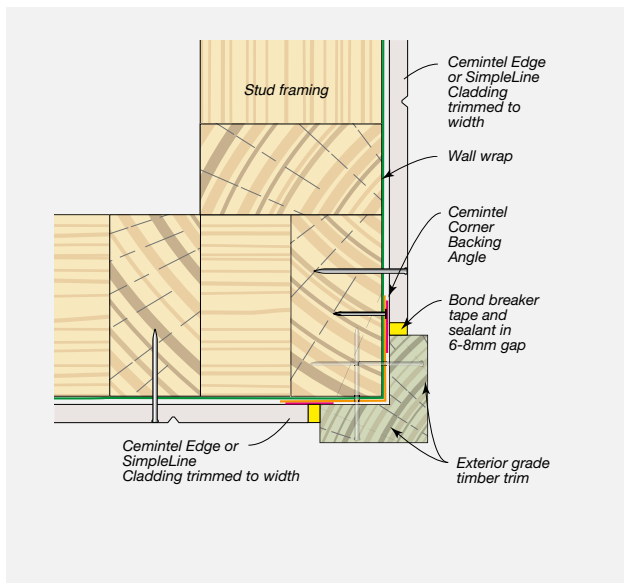
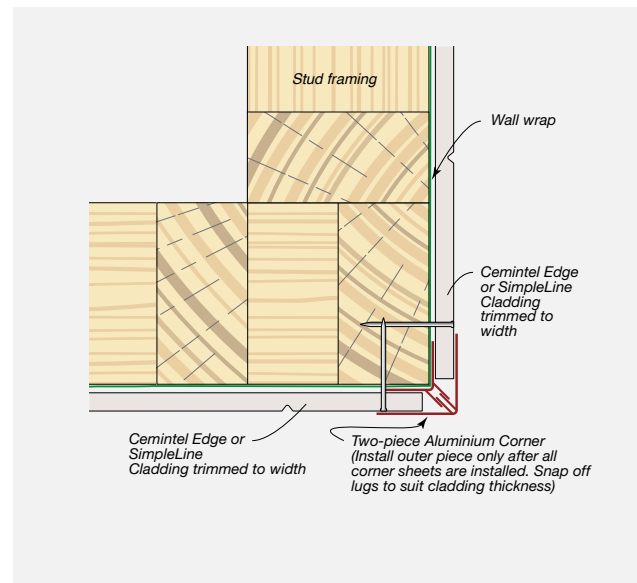

FIGURE 8.15 External Corner with Two-piece Aluminium Corner



CONSTRUCTION DRAWINGS AND DETAILS



Edge Cladding + SimpleLine Vertical Installation – Direct Fix System

FIGURE 8.16 Obtuse Angle Corner Detail – With Metal Flashing – Direct Fixed Sheets

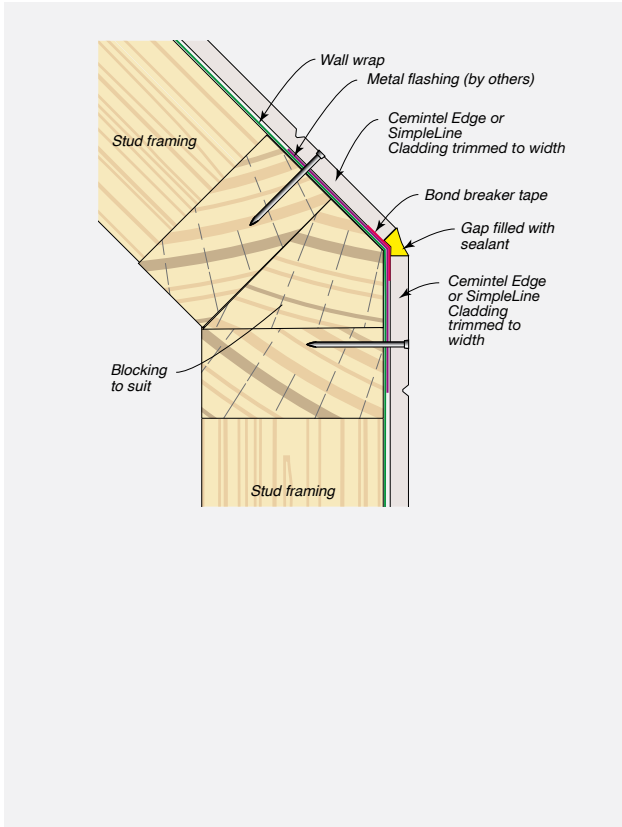

FIGURE 8.17 Internal Corner with Sealant

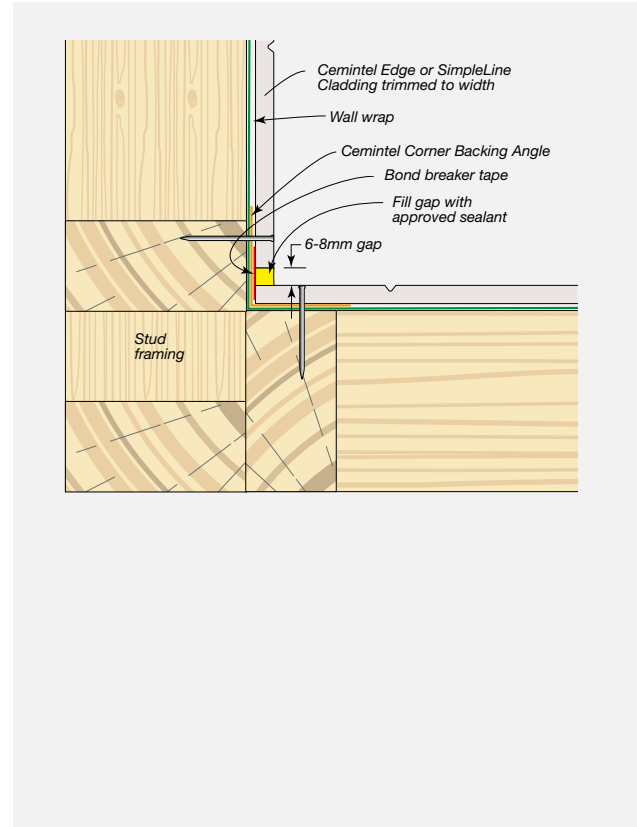

FIGURE 8.18 Internal Corner with Timber Trim

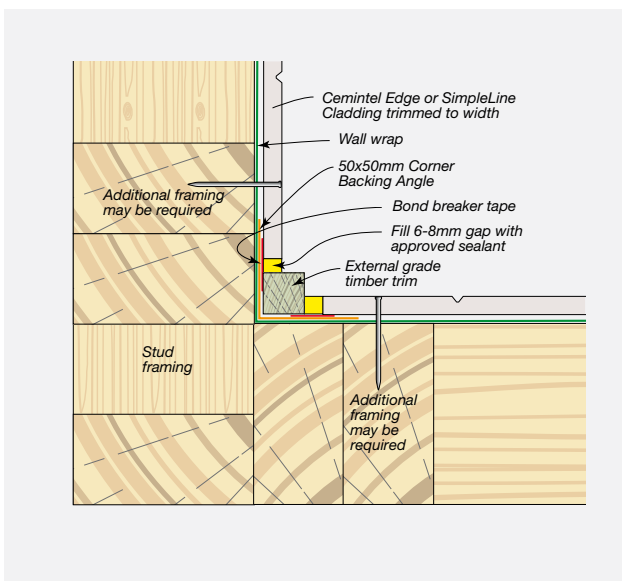
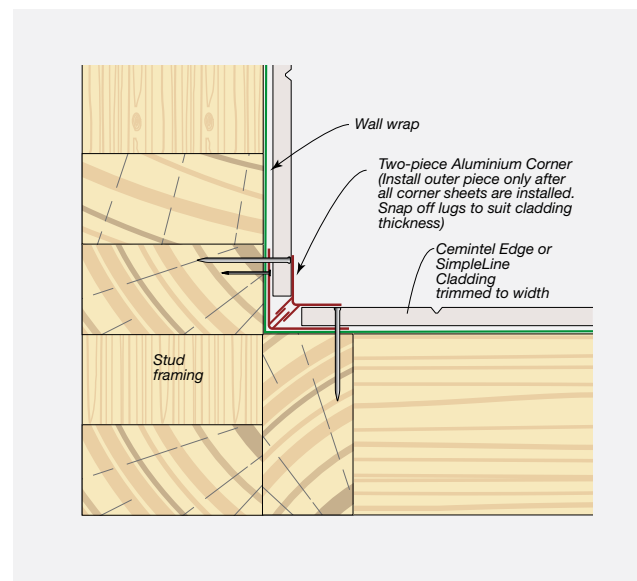

FIGURE 8.19 Internal Corner with Two-piece Aluminium Corner





CONSTRUCTION DRAWINGS AND DETAILS

Edge Cladding + SimpleLine Vertical Installation – Direct Fix System

FIGURE 8.20 Soffit Detail

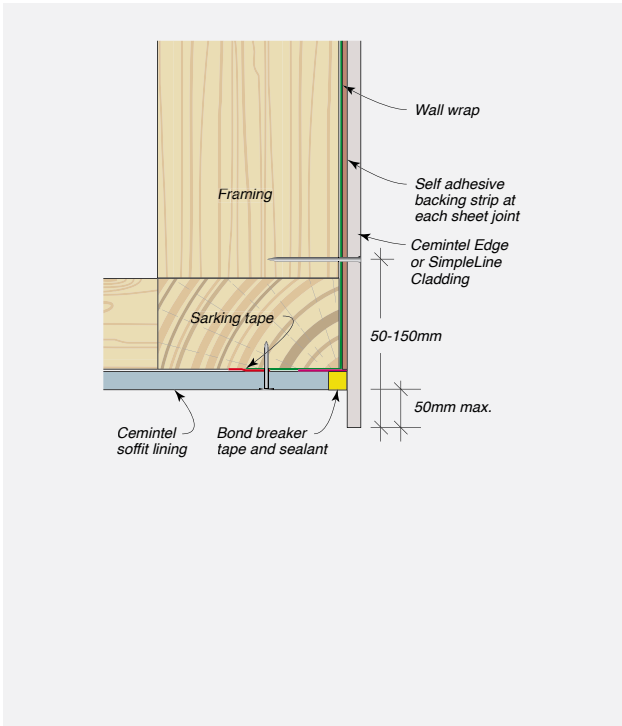

FIGURE 8.21 Head Detail – Eaves

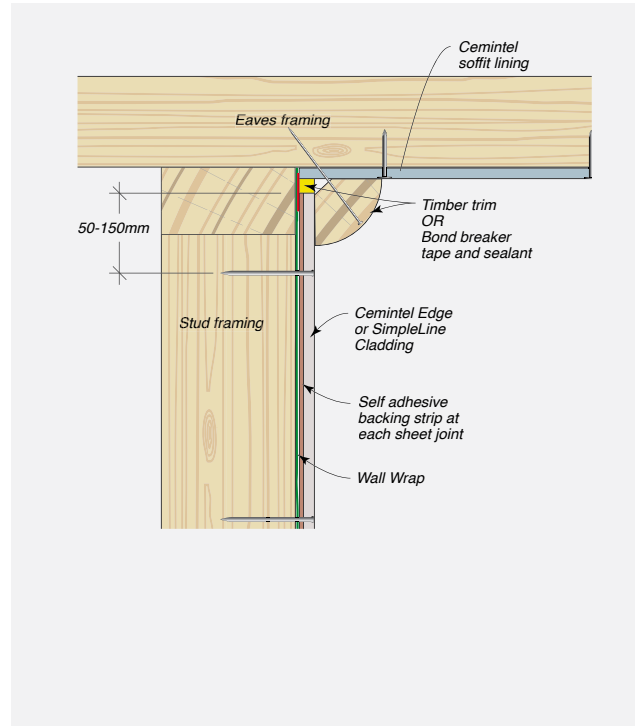

FIGURE 8.22 Second Storey Horizontal Junction

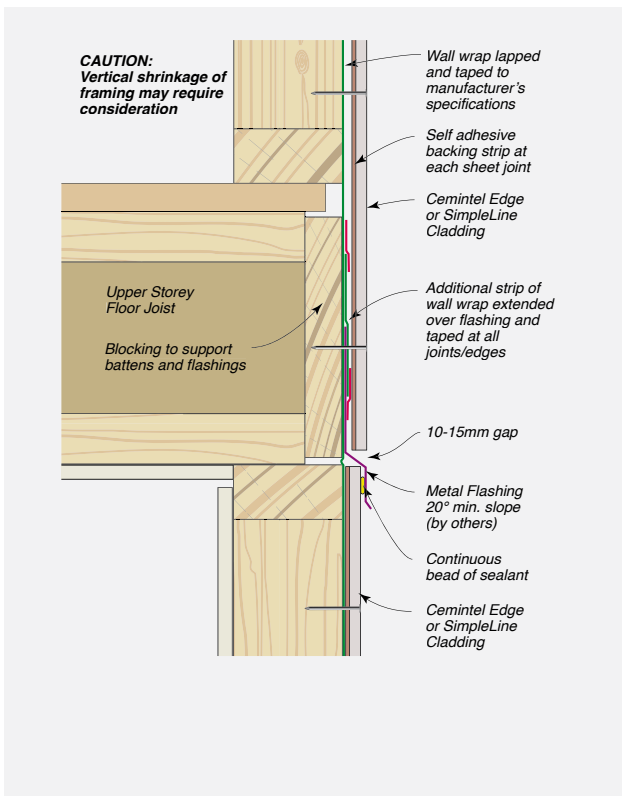
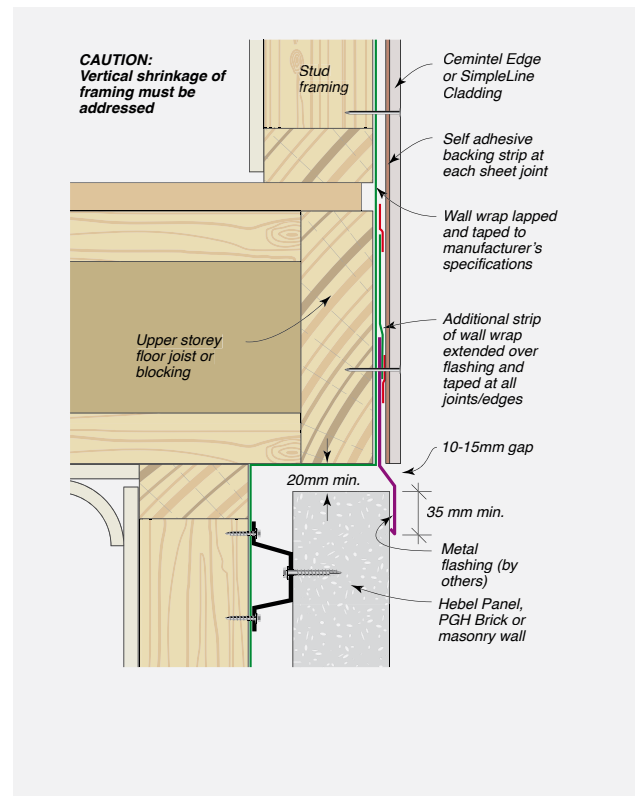

FIGURE 8.23 Typical Second Storey Junction with Hebel Panels, Brick Veneer or Masonry Wall – Cantilevered Framing



CONSTRUCTION DRAWINGS AND DETAILS



Edge Cladding + SimpleLine Vertical Installation – Direct Fix System

FIGURE 8.24 Typical Second Storey Junction with Hebel Panels, Brick Veneer or Masonry – In-line Framing

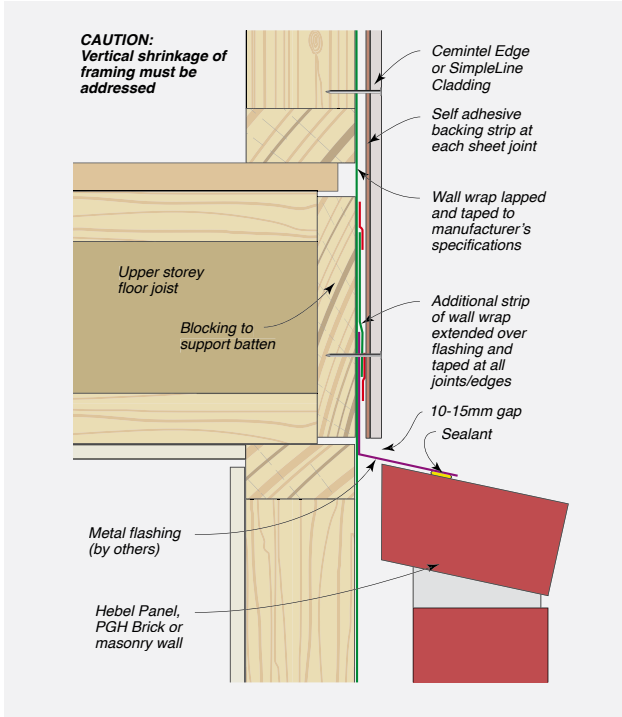

FIGURE 8.25 Junction of Edge Cladding System with Alternative Fibre Cement Cladding – Plan View

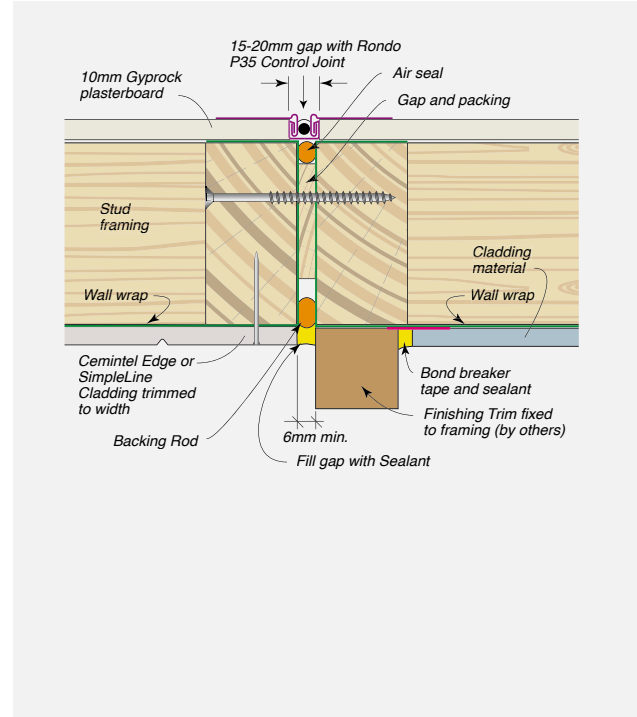

FIGURE 8.26 Junction of Edge Cladding System with Offset or In-line Masonry Wall – Plan View

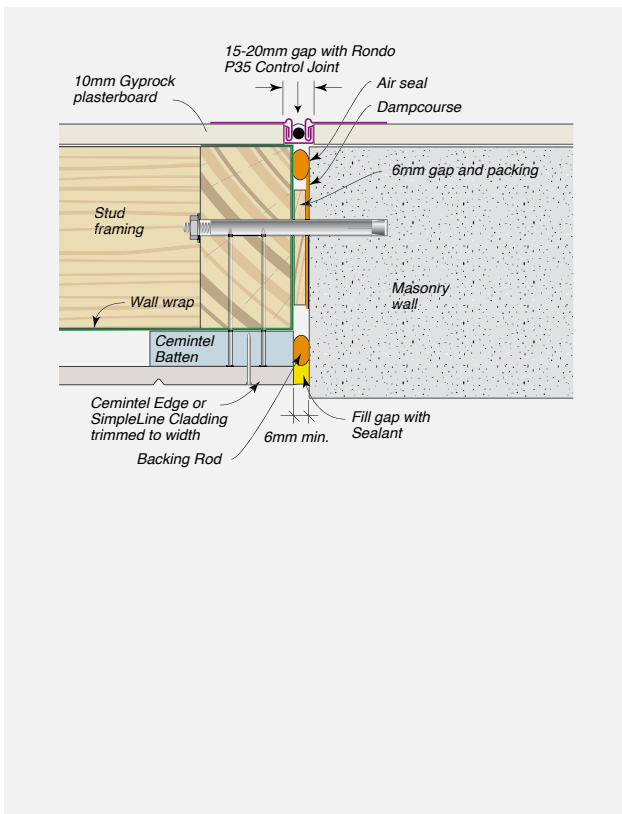
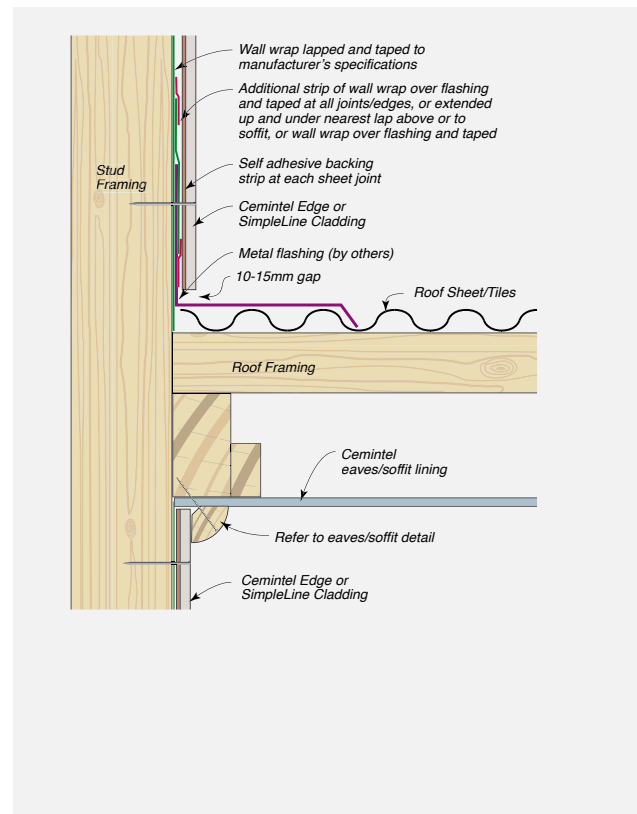

FIGURE 8.27 Junction of Cladding with External Parallel Roofing





CONSTRUCTION DRAWINGS AND DETAILS

Edge Cladding + SimpleLine Vertical Installation – Direct Fix System

FIGURE 8.28 Junction of Cladding with External Perpendicular Roofing

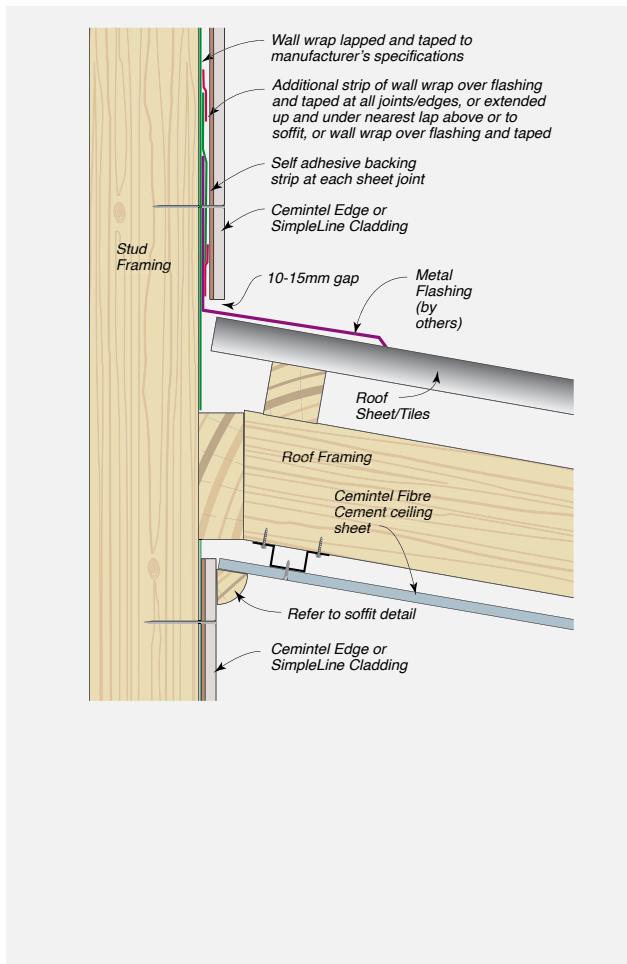
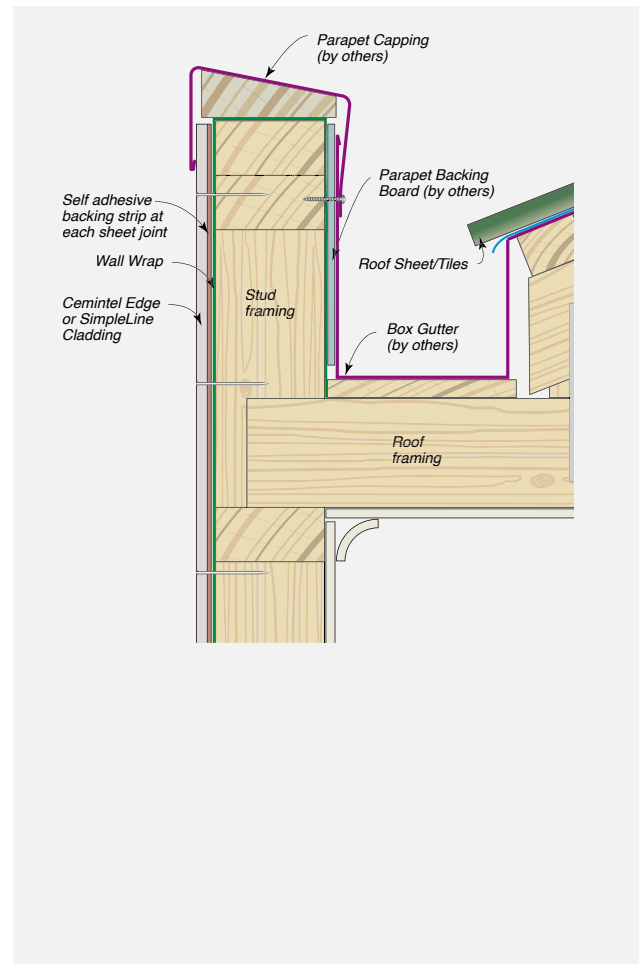

FIGURE 8.29 Horizontal Parapet – Elevation



CONSTRUCTION DRAWINGS AND DETAILS



Edge Cladding + SimpleLine Vertical Installation – Direct Fix System

FIGURE 8.30 Typical Window Installation

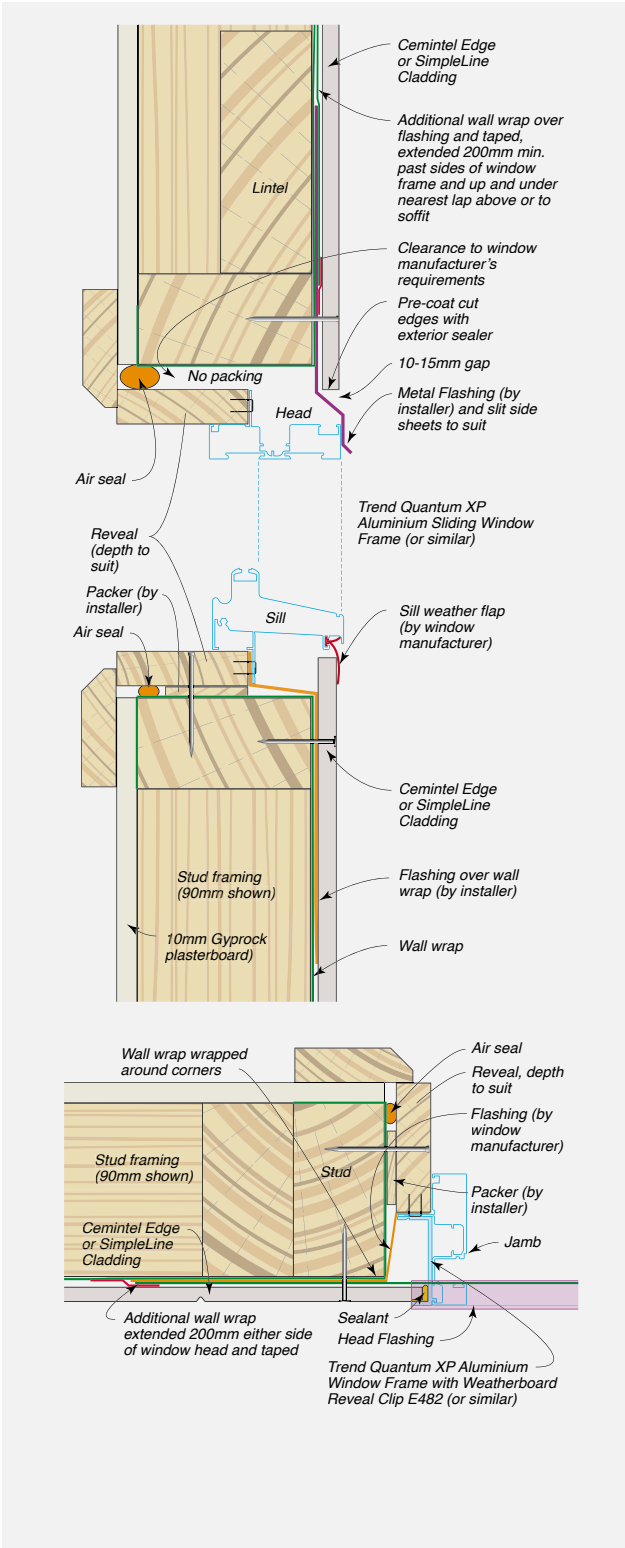
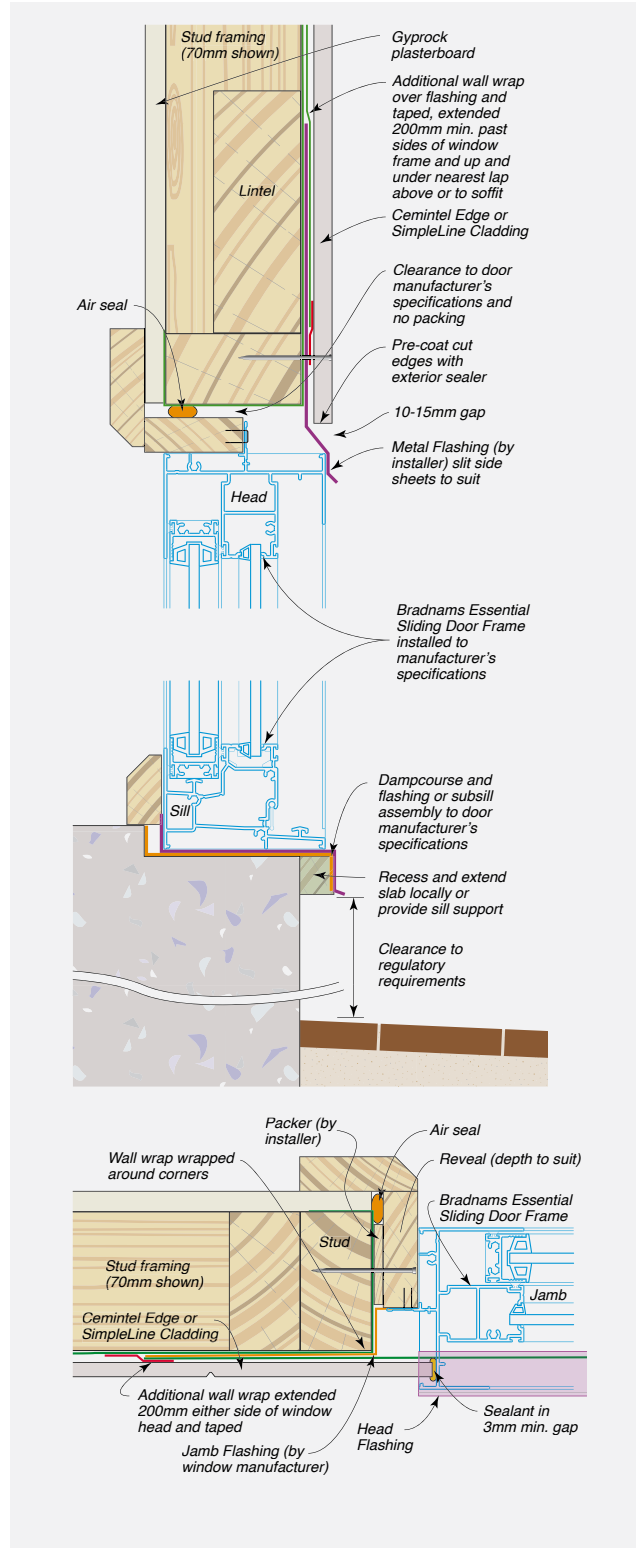

FIGURE 8.31 Typical Sliding Door Installation – 70mm Framing Shown





CONSTRUCTION DRAWINGS AND DETAILS

Edge Cladding + SimpleLine Vertical Installation – Direct Fix System

FIGURE 8.32 Typical Power Meter Box – Recessed Installation

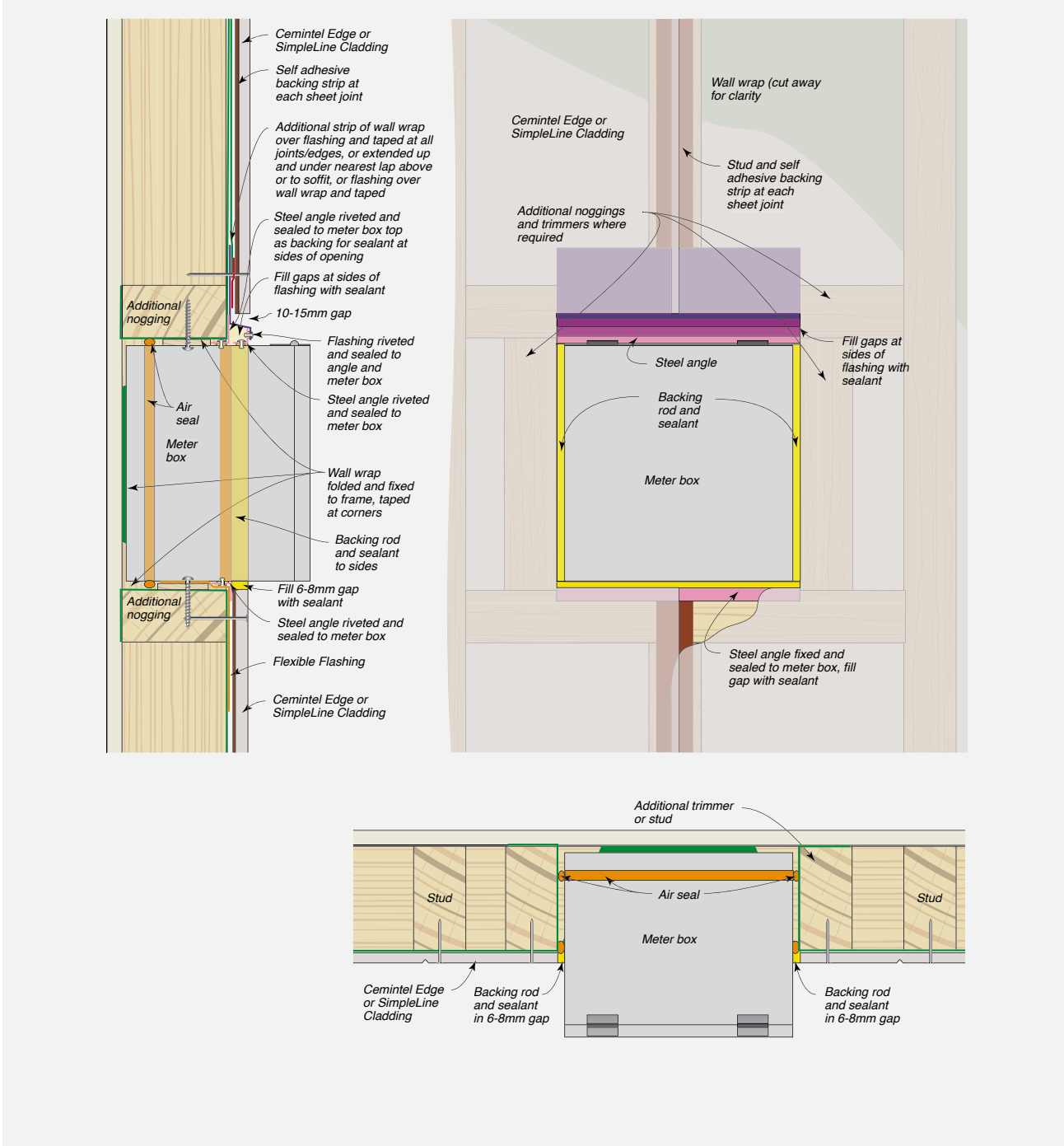

CONSTRUCTION DRAWINGS AND DETAILS



Edge Cladding + SimpleLine Vertical Installation – Direct Fix System

FIGURE 8.33 Typical Power Meter Box – Face Mounted Installation

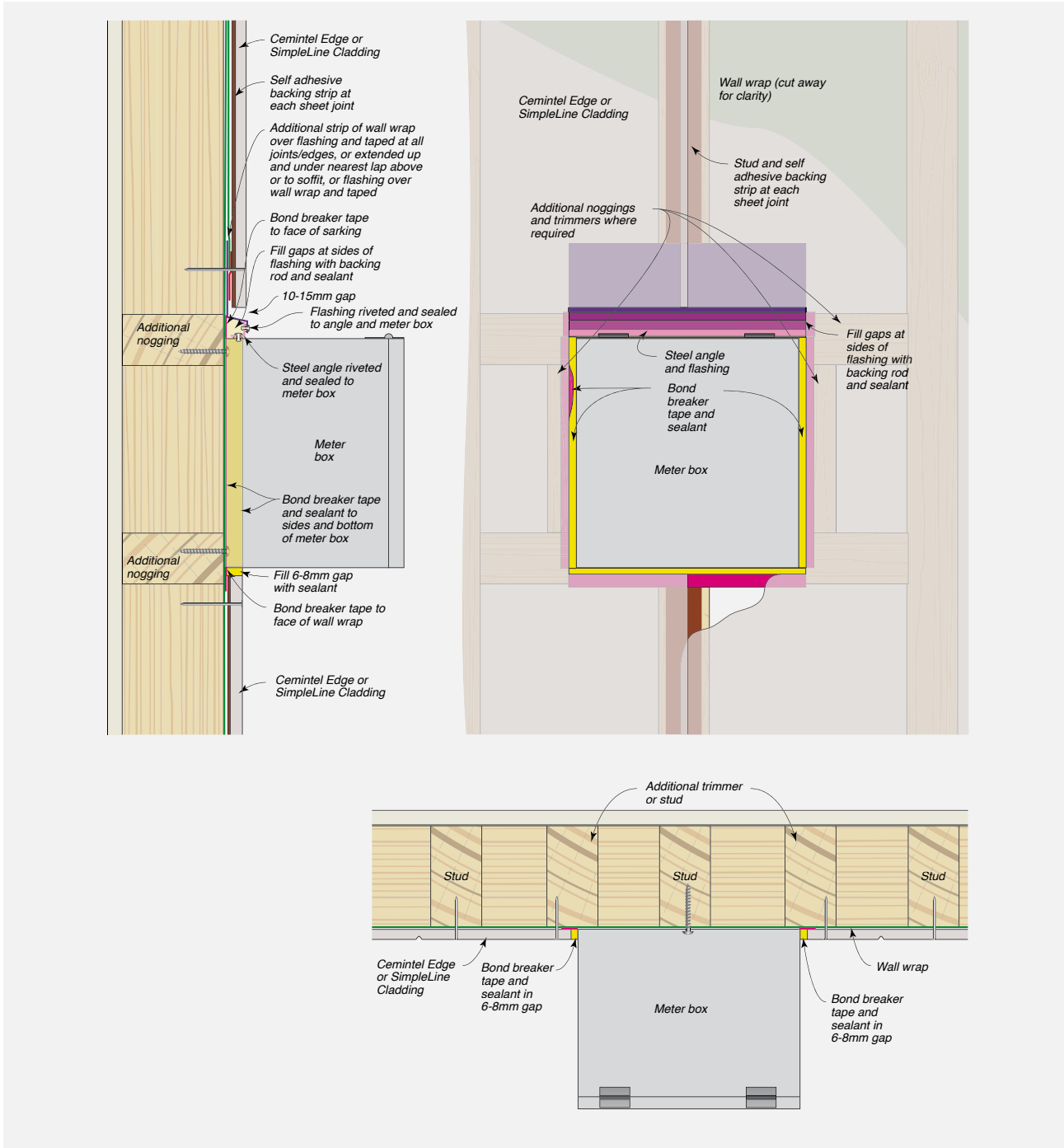



CONSTRUCTION DRAWINGS AND DETAILS

Edge Cladding + SimpleLine Vertical Installation – Direct Fix System

FIGURE 8.34 Typical Edge Cladding Fire Rated Direct Fix Wall System Layout

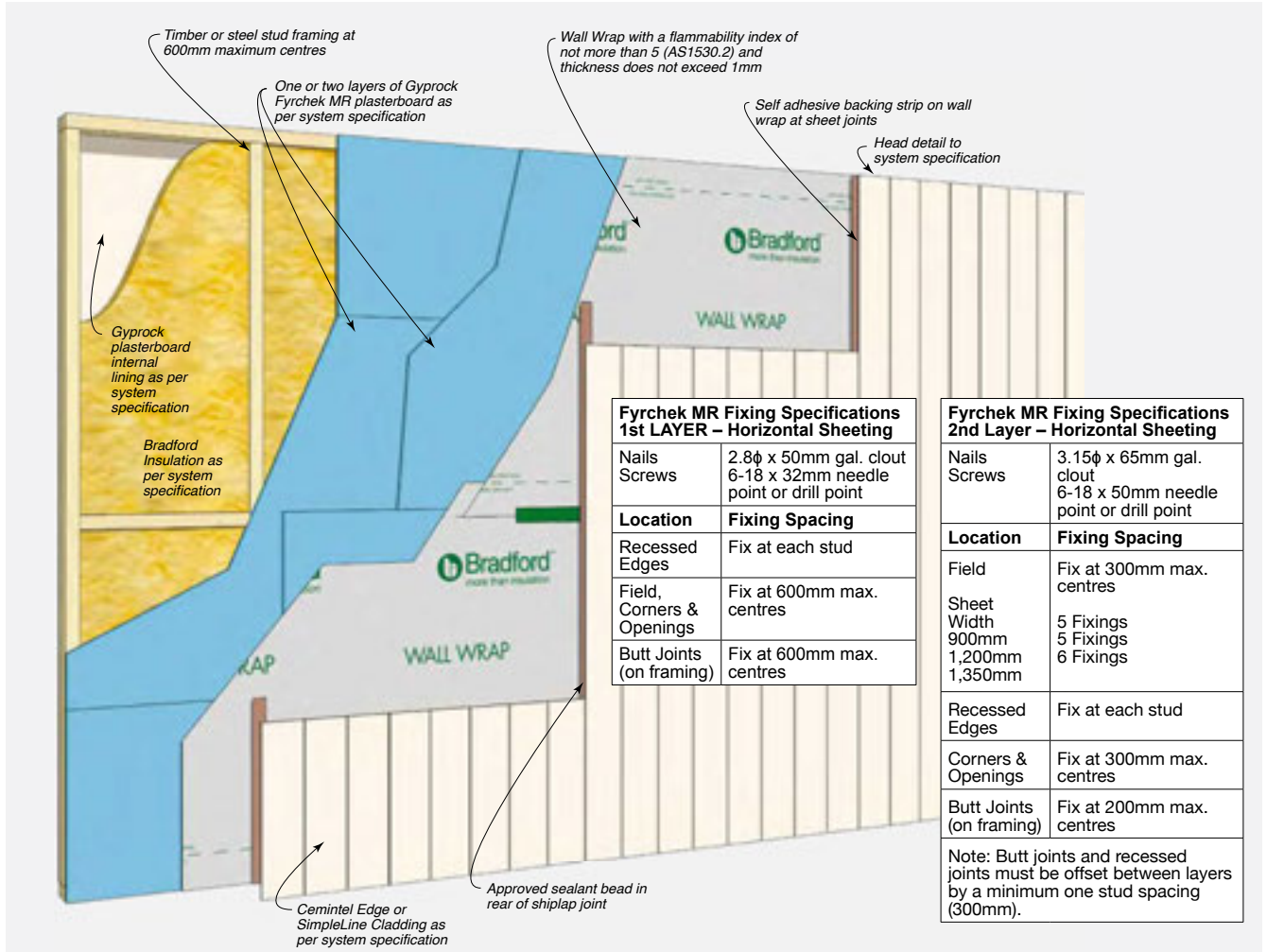

NOTE: The length of the Cemintel cladding fixings will need to be increased to ensure the same or greater embedment depth for single and double fire-rated linings. Nail fixing through multiple layers can be difficult and screw fixings are the preferred method of construction.

CONSTRUCTION DRAWINGS AND DETAILS



Edge Cladding + SimpleLine Vertical Installation – Cavity Fix System

SECTION	DESCRIPTION	FIGURE REFERENCE	PAGE NUMBER
DIRECT FIX			
General Details	Typical Cemintel Edge or SimpleLine Installation – Cavity Fixed System	8.35	48
Panel Fixing Details	Vertical Joint – Cladding Fixed to Structural Cemintel FC Batten – Edge Ribbon-Groove	8.36	49
	Vertical Joint – Cladding Fixed Through Non-structural Batten to Framing – Edge Ribbon-Groove	8.37	49
	Vertical Joint – Cladding Fixed to Structural Cemintel FC Batten – Edge V-Groove	8.38	49
	Vertical Joint – Cladding Fixed Through Non-structural Batten to Framing – Edge V-Groove	8.39	49
	Vertical Joint – Cladding Fixed to Structural Cemintel FC Batten – SimpleLine	8.40	50
	Vertical Joint – Cladding Fixed Through Non-structural Batten to Framing – SimpleLine	8.41	50
	Vertical Joint – Cladding Fixed to Structural Cemintel FC Batten – Steel Framing – Edge Ribbon-Groove	8.42	50
	Vertical Joint – Cladding Fixed to Structural Cemintel FC Batten – Steel Framing – Edge V-Groove	8.43	50
	Vertical Joint – Cladding Fixed to Structural Cemintel FC Batten – Steel Framing – SimpleLine	8.44	50
	Vertical Joint – Cladding Fixed to Structural Top Hat Off Stud – Edge V-Groove	8.45	50
Base Details	Base – Concrete Slab Foundation	8.46	51
	Base – Pier or Stub Wall Foundation	8.47	51
Corner Details	External Corner with Sealant and Optional Timber Moulding	8.48	51
	External Corner with Two-piece Aluminium Corner	8.49	51
	Obtuse Angle Corner	8.50	52
	Internal Corner with Sealant and Optional Timber Moulding	8.51	52
	Internal Corner with Two-piece Aluminium Corner	8.52	52
Eaves/Soffit Details	Soffit – With Soffit Trim	8.53	52
	Head – Eaves with Cemintel Trim	8.54	53
	Head – Eaves with Timber Trim	8.55	53
Horizontal Junctions	Second Storey Horizontal Junction	8.56	53
	Second Storey Junction with Hebel Panels, Brick Veneer or Masonry Wall – Cantilevered Framing	8.57	53
	Second Storey Junction with Masonry, Brick Veneer or Hebel Panels In-line Framing	8.58	54
Vertical Junctions	Junction of Cemintel Cladding with Alternative Cladding	8.59	54
	Junction of Cemintel Cladding with Masonry Wall	8.60	54
	Junction of Edge Cladding with External Parallel Roofing	8.61	54
	Junction of Edge Cladding with External Perpendicular Roofing	8.62	55
Parapet Details	Horizontal Parapet Wall	8.63	55
Window/Door Details	Typical Sliding Window Installation	8.64	56
	Typical Sliding Window Installation	8.65	56
	Typical Sliding Door Installation	8.66	57
Meter Box Details	Typical Power Meter Box – Recessed Installation	8.67	58
	Typical Power Meter Box – Face Fix Installation	8.68	59
Fire Details	Typical Edge Cladding Fire Rated Cavity Fix Wall System Layout	8.69	60

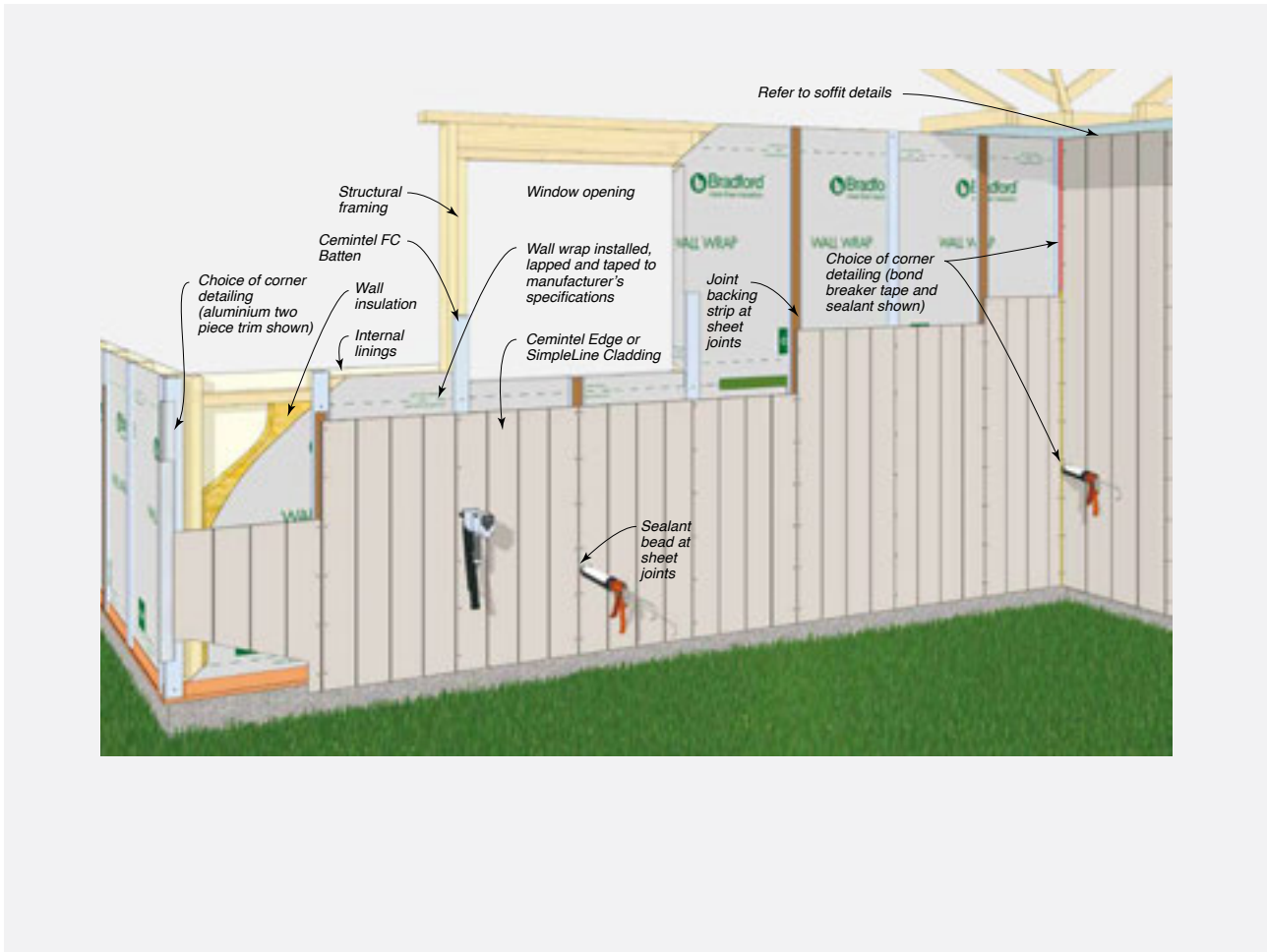

CONSTRUCTION DRAWINGS AND DETAILS

Edge Cladding + SimpleLine Vertical Installation – Cavity Fix System**FIGURE 8.35** Typical Cemintel Edge or SimpleLine Installation – Cavity Fixed System

CONSTRUCTION DRAWINGS AND DETAILS



Edge Cladding + SimpleLine Vertical Installation – Cavity Fix System

FIGURE 8.36 Vertical Joint – Cladding Fixed to Structural Cemintel FC Batten – Edge RIBBON-Groove

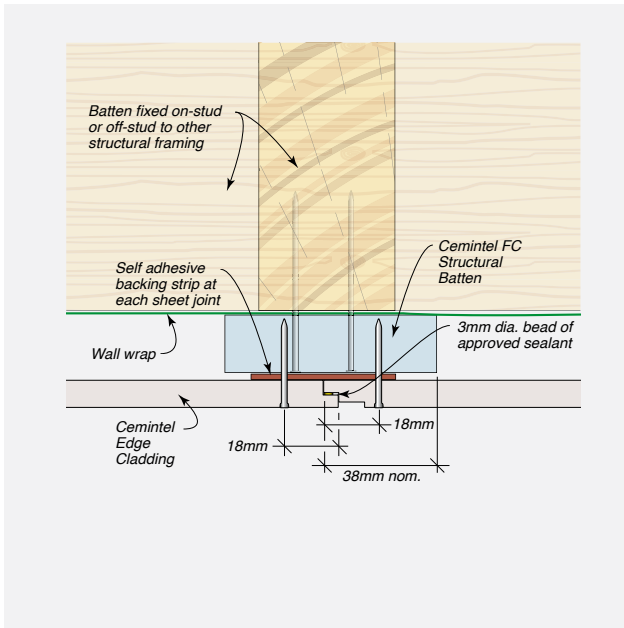

FIGURE 8.37 Vertical Joint – Cladding Fixed Through Non-structural Batten to Framing – Edge RIBBON-Groove

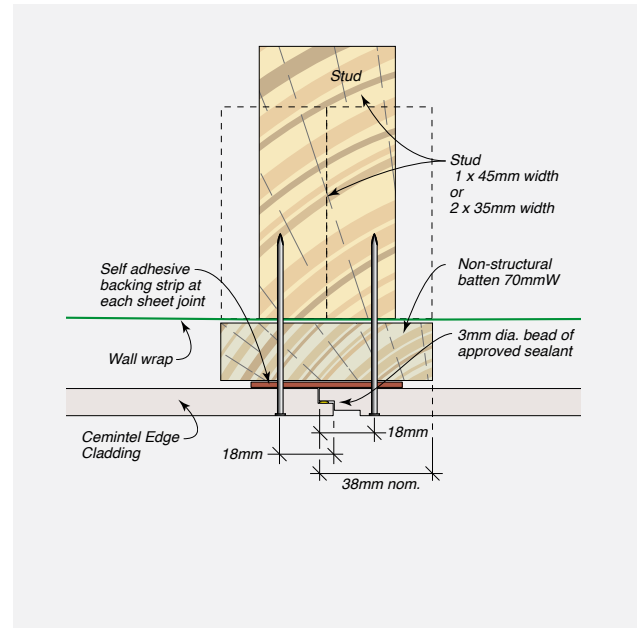

FIGURE 8.38 Vertical Joint – Cladding Fixed to Structural Cemintel FC Batten – Edge V-Groove

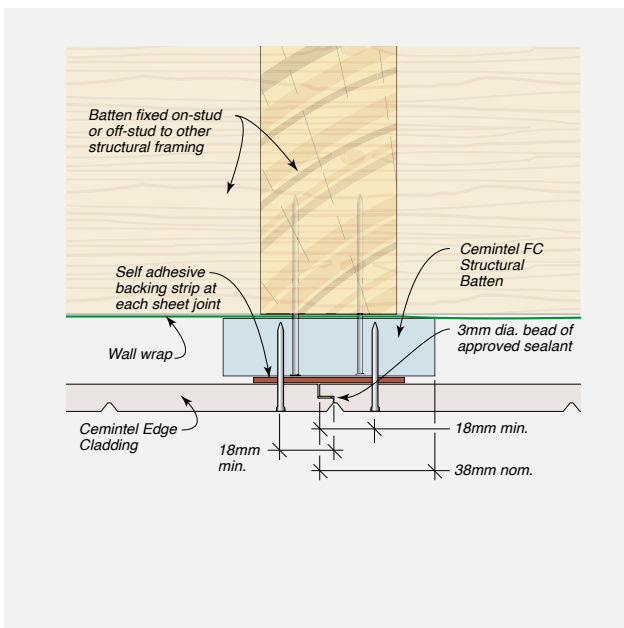
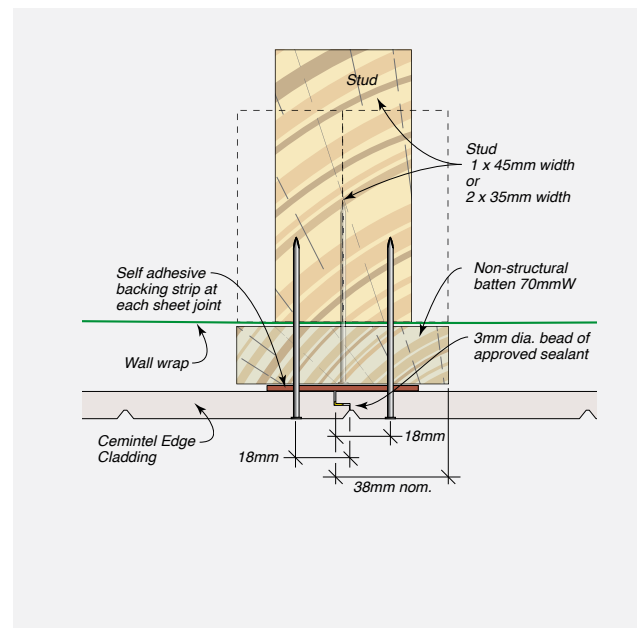

FIGURE 8.39 Vertical Joint – Cladding Fixed Through Non-structural Batten to Framing – Edge V-Groove





CONSTRUCTION DRAWINGS AND DETAILS

Edge Cladding + SimpleLine Vertical Installation – Cavity Fix System

FIGURE 8.40 Vertical Joint – Cladding Fixed to Structural Cemintel FC Batten – SimpleLine

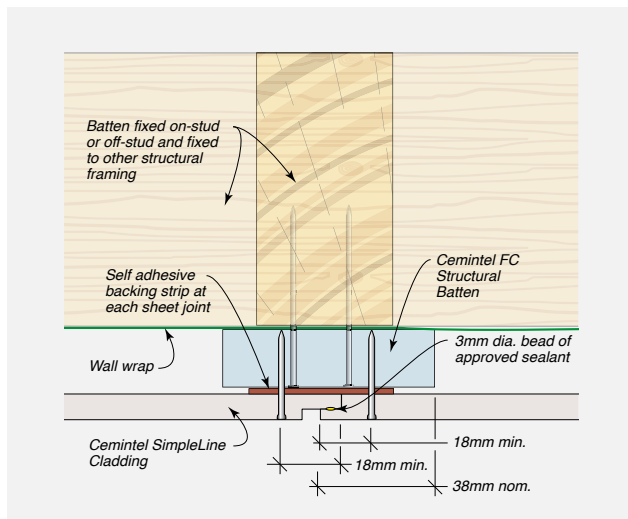

FIGURE 8.41 Vertical Joint – Cladding Fixed Through Non-structural Batten to Framing – SimpleLine

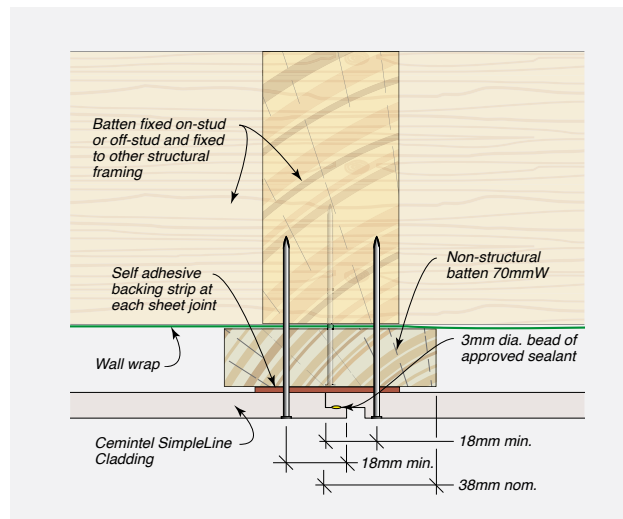

FIGURE 8.42 Vertical Joint – Cladding Fixed to Structural Cemintel FC Batten – Steel Framing – Edge RIBBON-Groove

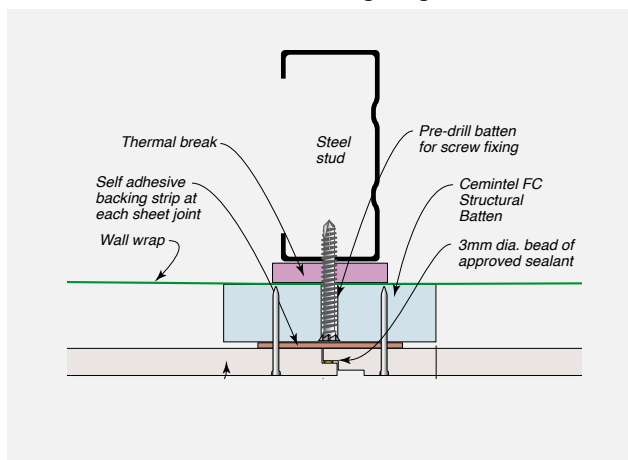

FIGURE 8.43 Vertical Joint – Cladding Fixed to Structural Cemintel FC Batten – Steel Framing – Edge V-Groove

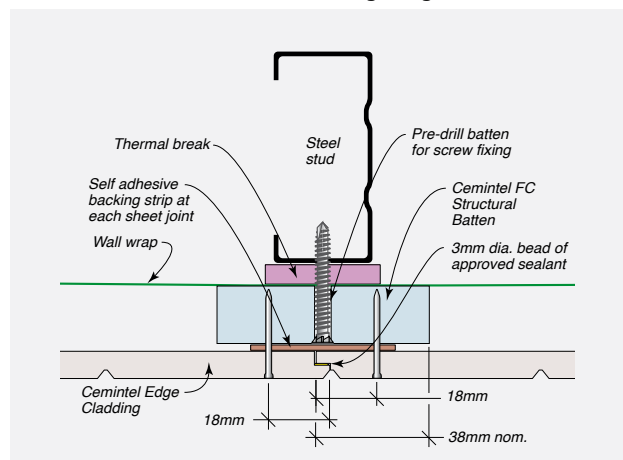

FIGURE 8.44 Vertical Joint – Cladding Fixed to Structural Top Hat Off Stud – SimpleLine

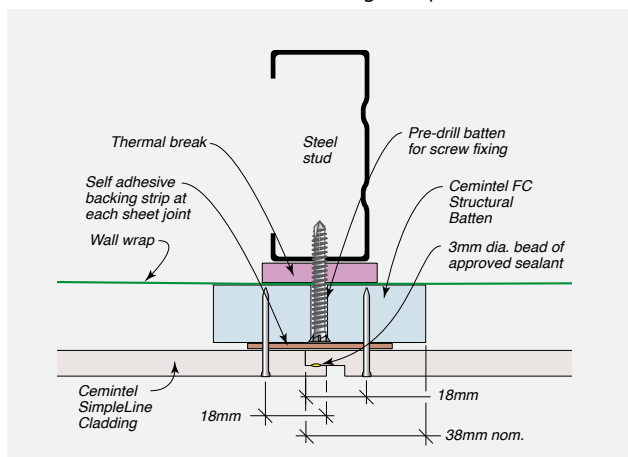
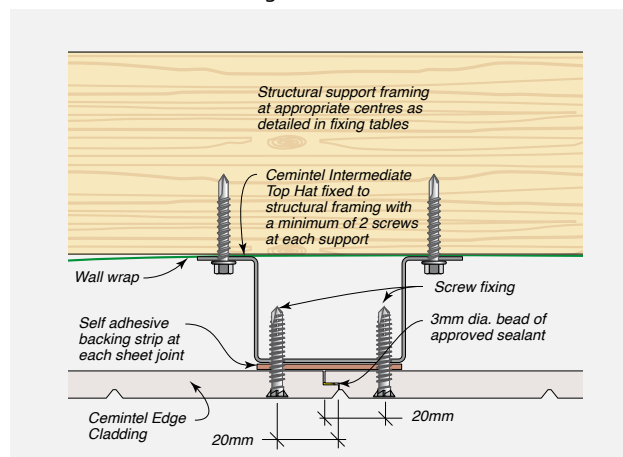

FIGURE 8.45 Vertical Joint – Cladding Fixed to Structural Top Hat Off Stud – Edge V-Groove



CONSTRUCTION DRAWINGS AND DETAILS



Edge Cladding + SimpleLine Vertical Installation – Cavity Fix System

FIGURE 8.46 Base – Concrete Slab Foundation

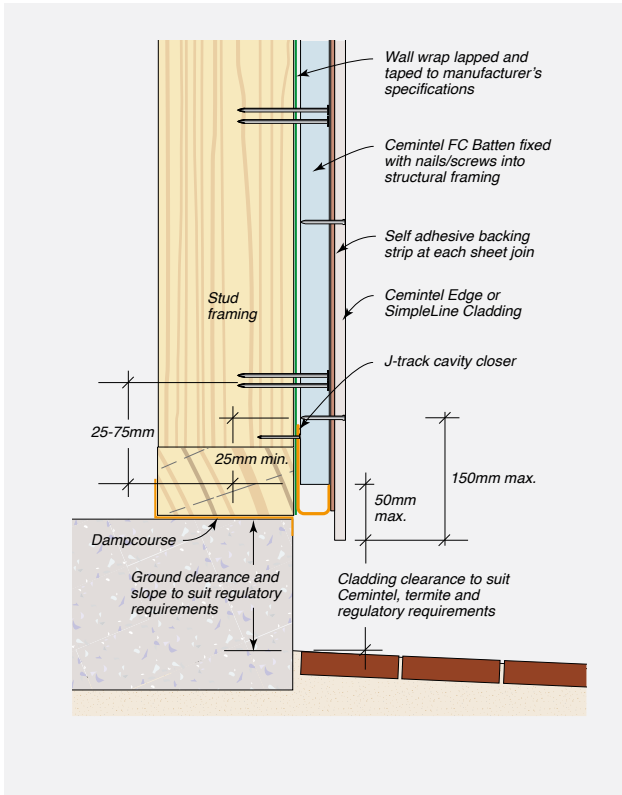

FIGURE 8.47 Base – Pier or Stub Wall Foundation

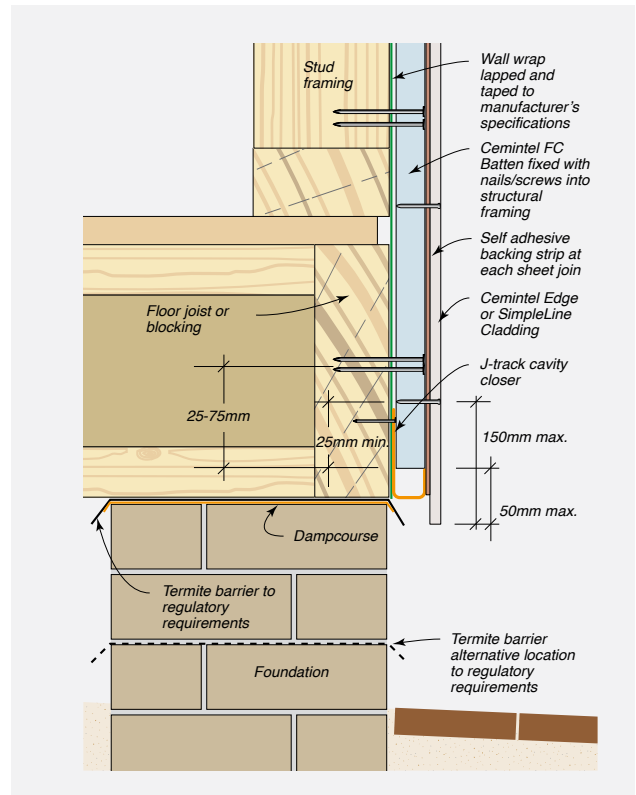

FIGURE 8.48 External Corner with Sealant and Optional Timber Moulding

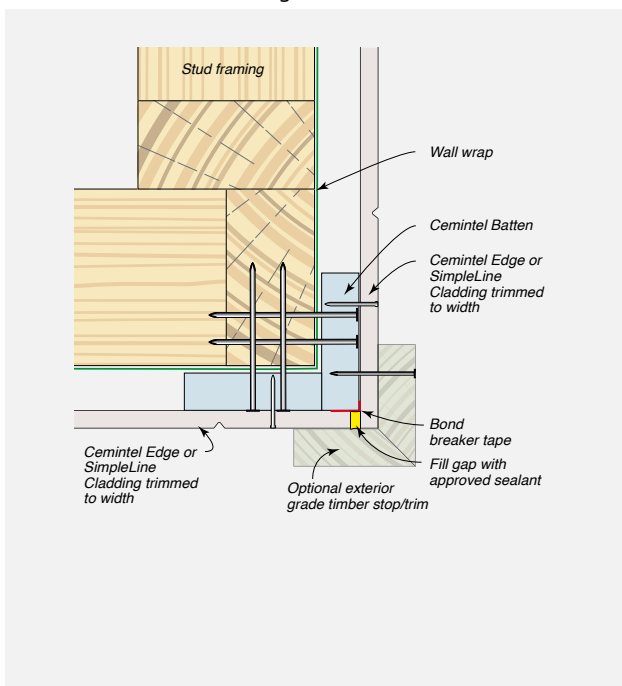
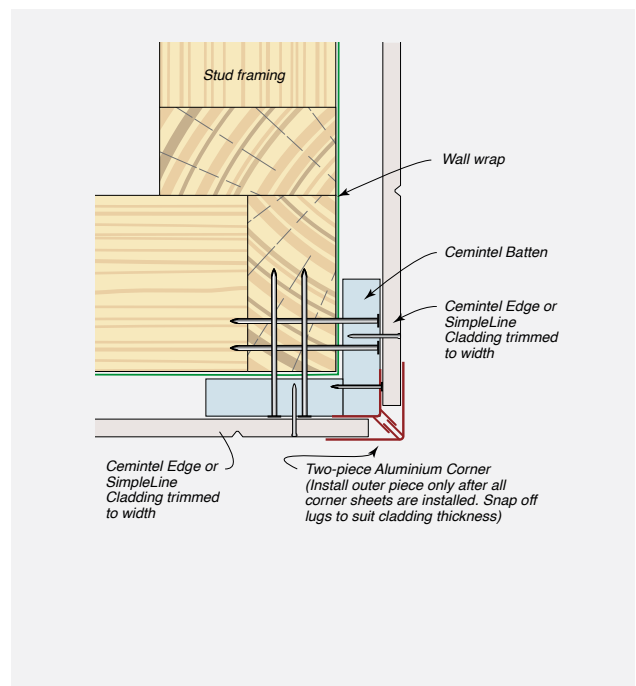

FIGURE 8.49 External Corner with Two-piece Aluminium Corner





CONSTRUCTION DRAWINGS AND DETAILS

Edge Cladding + SimpleLine Vertical Installation – Cavity Fix System

FIGURE 8.50 Obtuse Angle Corner

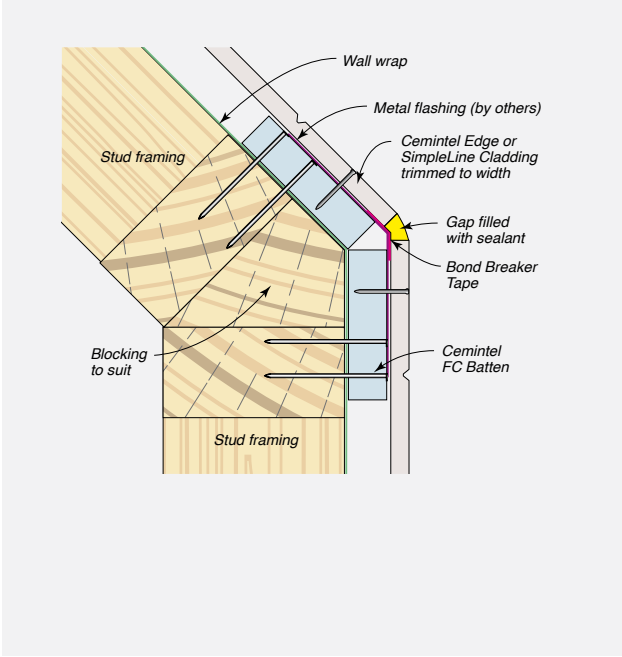

FIGURE 8.51 Internal Corner with Sealant and Optional Timber Moulding

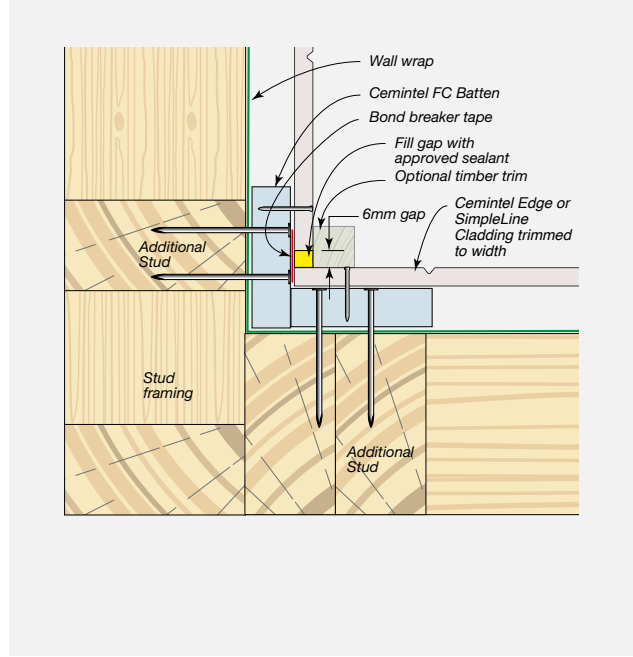

FIGURE 8.52 Internal Corner with Two-piece Aluminium Corner

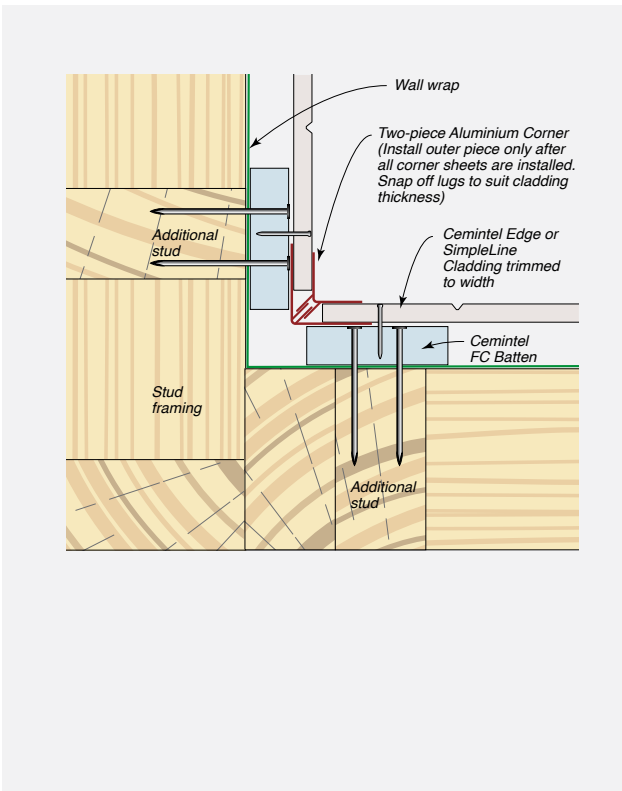
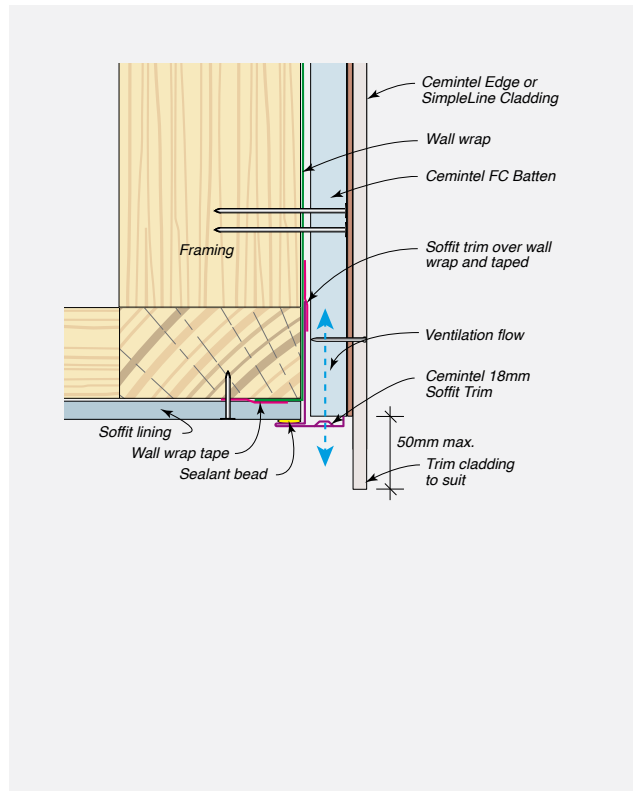

FIGURE 8.53 Soffit – With Soffit Trim



CONSTRUCTION DRAWINGS AND DETAILS



Edge Cladding + SimpleLine Vertical Installation – Cavity Fix System

FIGURE 8.54 Head – Eaves with Cemintel Trim

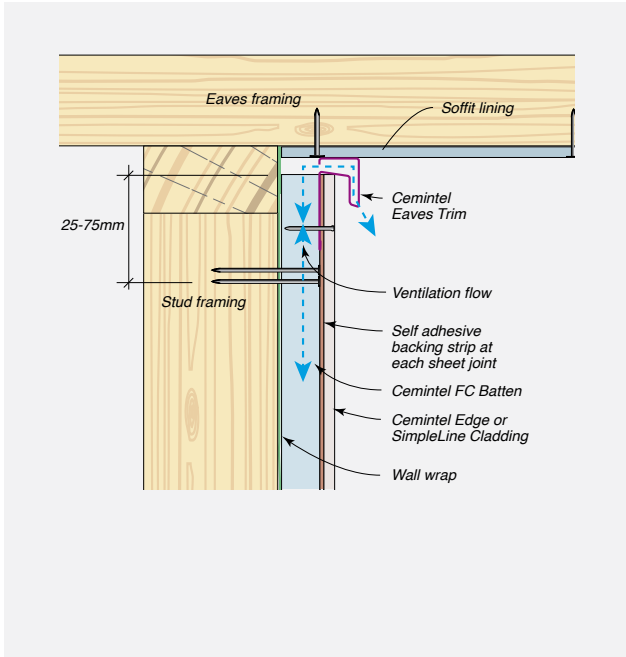

FIGURE 8.55 Head – Eaves with Timber Trim

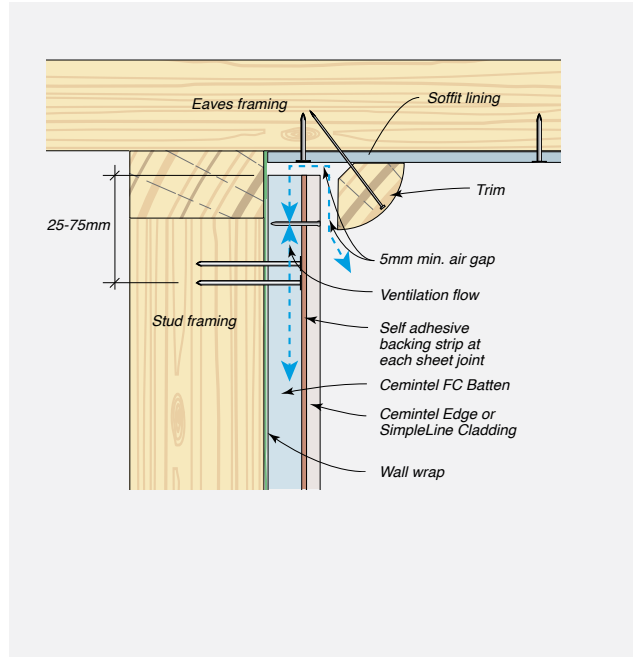

FIGURE 8.56 Second Storey Horizontal Junction

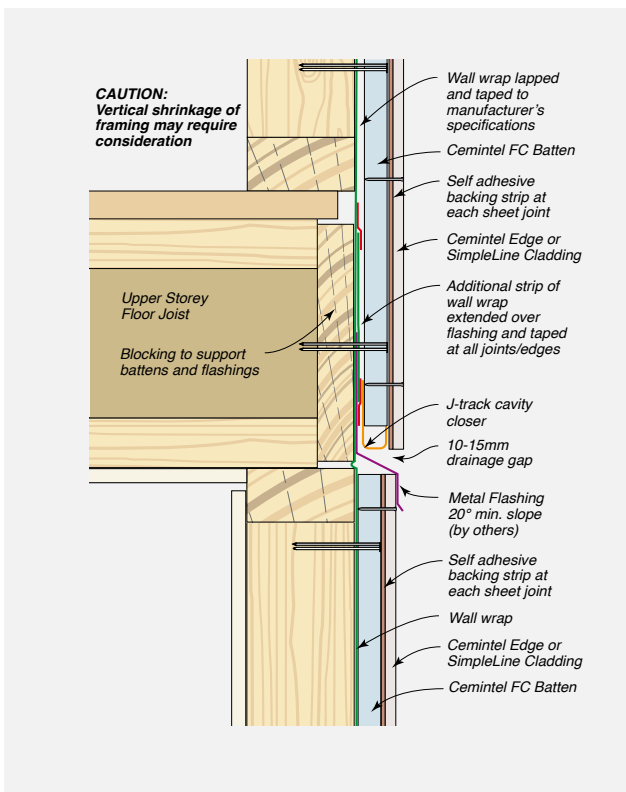
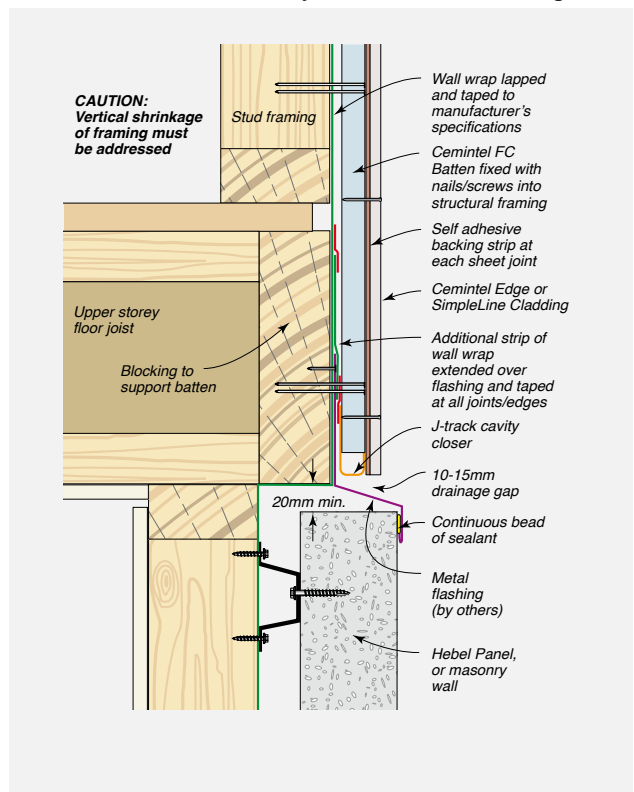

FIGURE 8.57 Second Storey Junction with Hebel Panels, Brick Veneer or Masonry Wall – Cantilevered Framing





CONSTRUCTION DRAWINGS AND DETAILS

Edge Cladding + SimpleLine Vertical Installation – Cavity Fix System

FIGURE 8.58 Second Storey Junction with Masonry, Brick Veneer or Hebel Panels In-line Framing

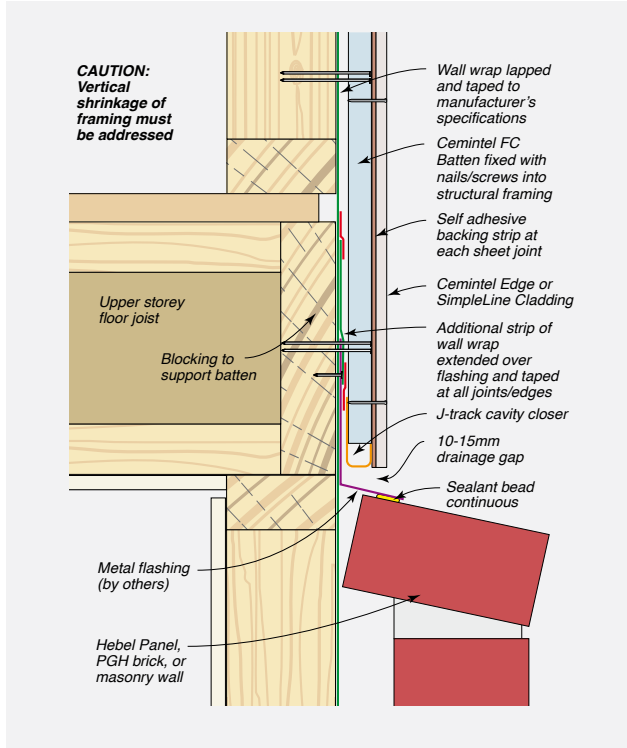

FIGURE 8.60 Junction of Cemintel Cladding with Masonry Wall

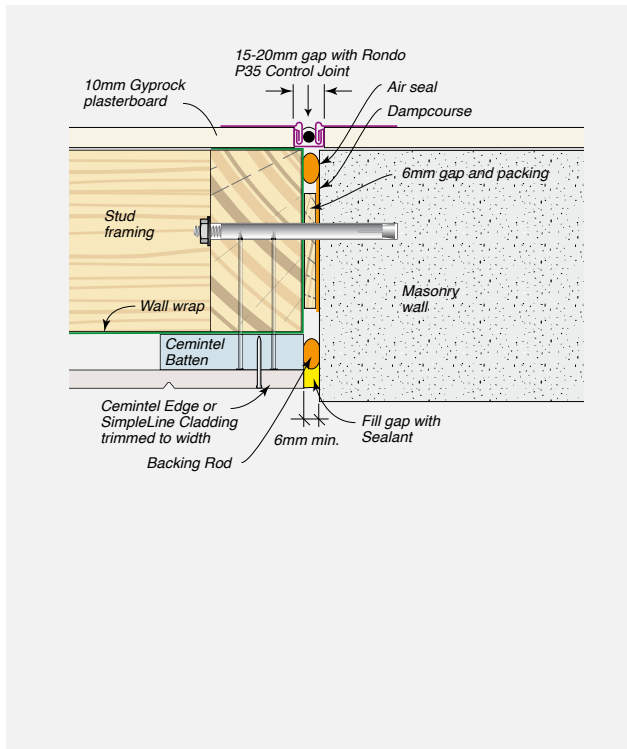

FIGURE 8.59 Junction of Cemintel Cladding with Alternative Cladding

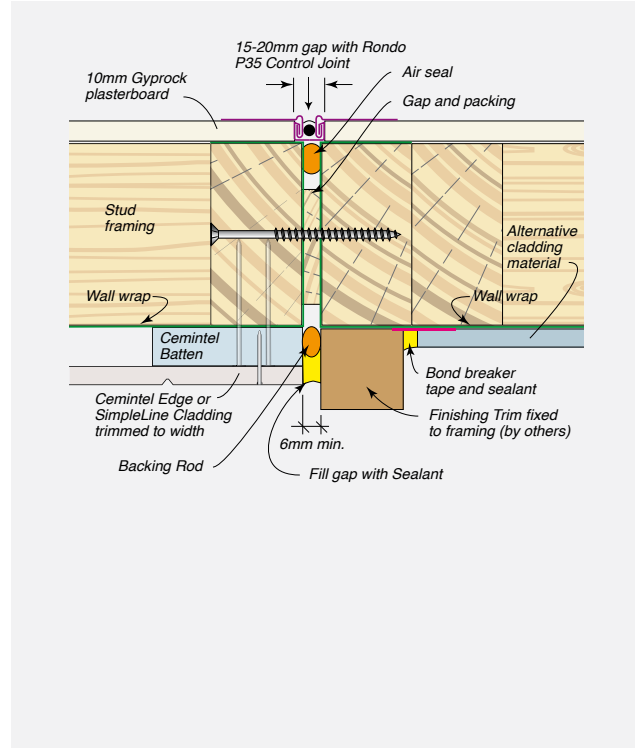
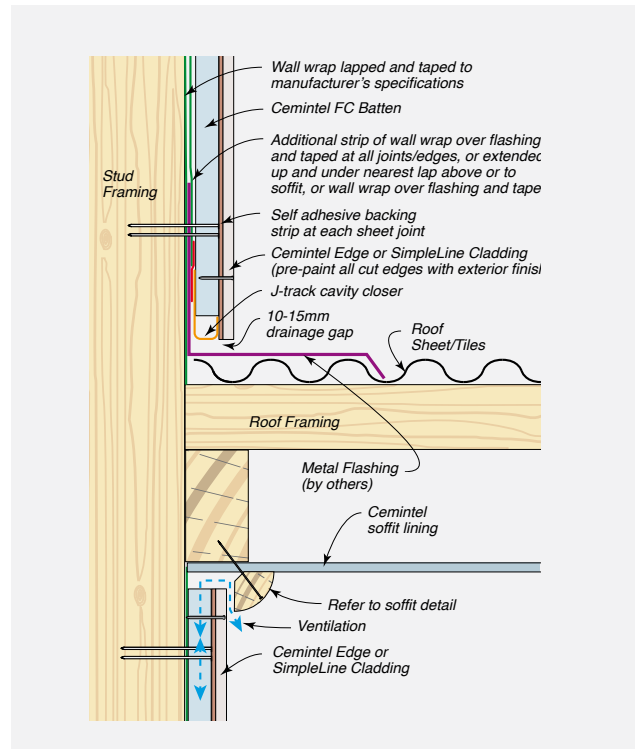

FIGURE 8.61 Junction of Edge Cladding with External Parallel Roofing



CONSTRUCTION DRAWINGS AND DETAILS



Edge Cladding + SimpleLine Vertical Installation – Cavity Fix System

FIGURE 8.62 Junction of Edge Cladding with External Perpendicular Roofing

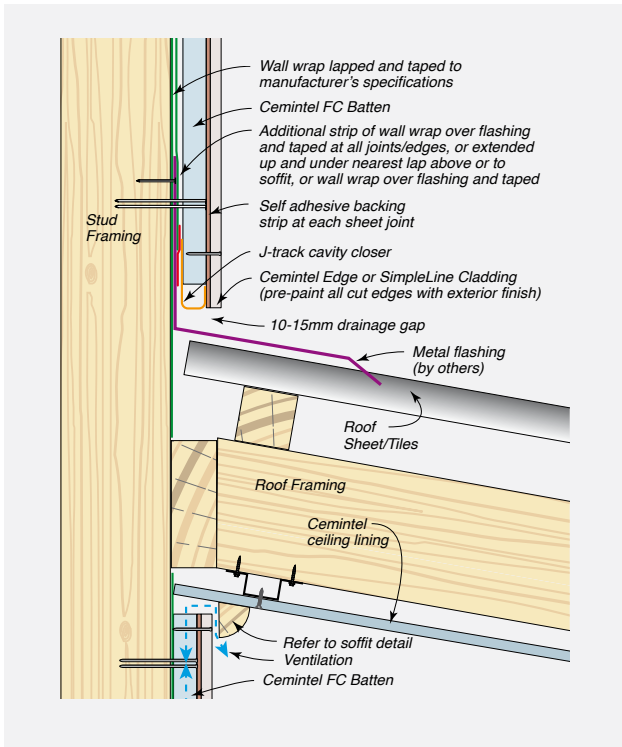
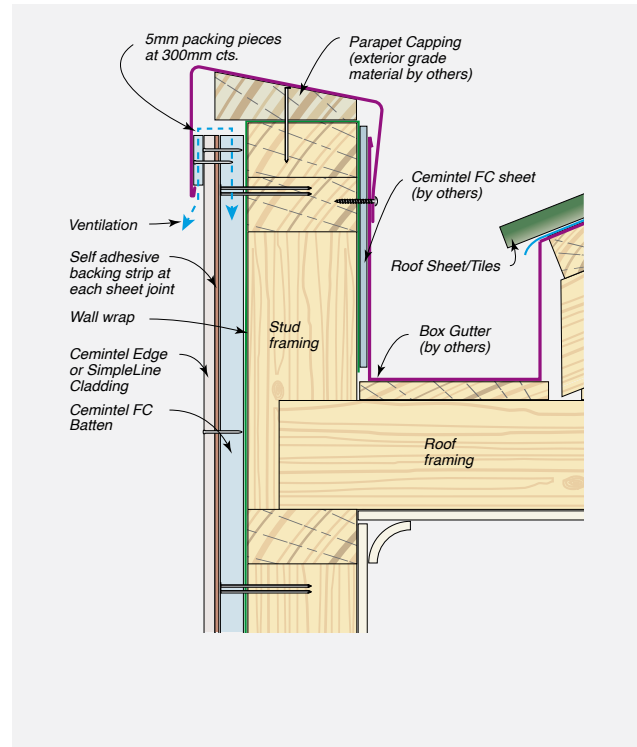

FIGURE 8.63 Horizontal Parapet Wall





CONSTRUCTION DRAWINGS AND DETAILS

Edge Cladding + SimpleLine Vertical Installation – Cavity Fix System

FIGURE 8.64 Typical Sliding Window Installation

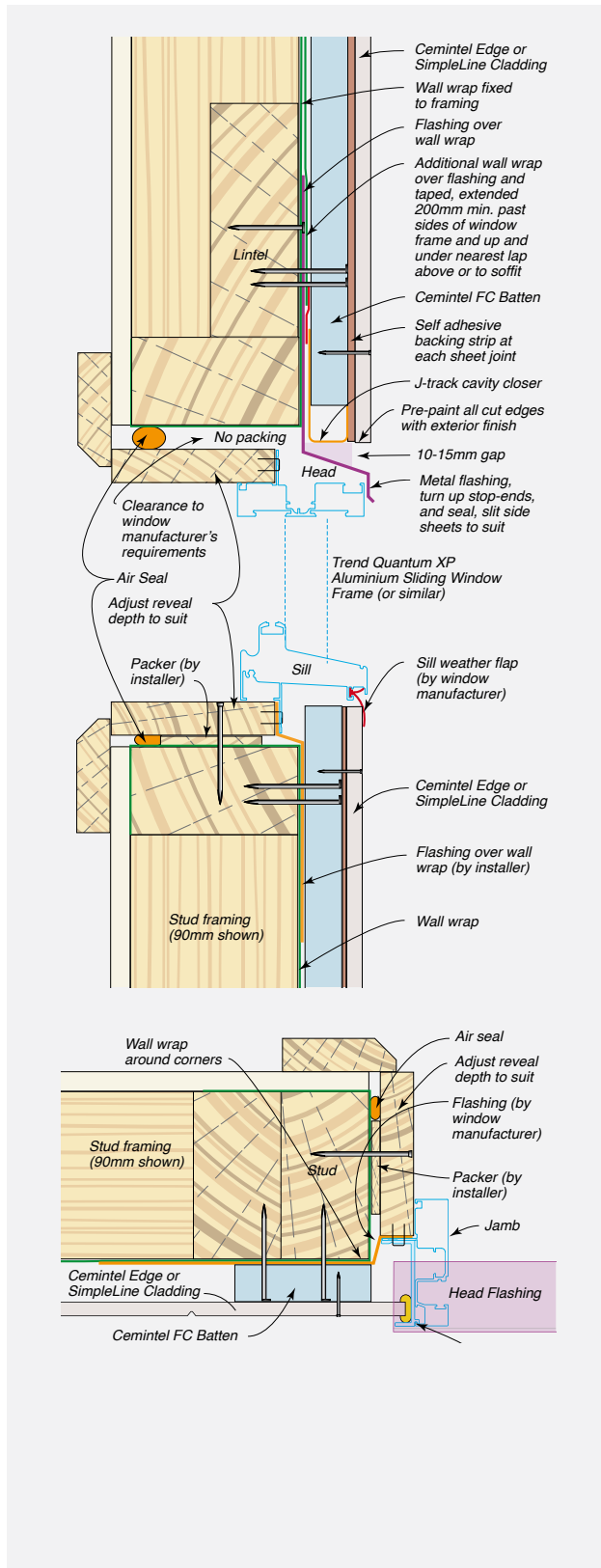
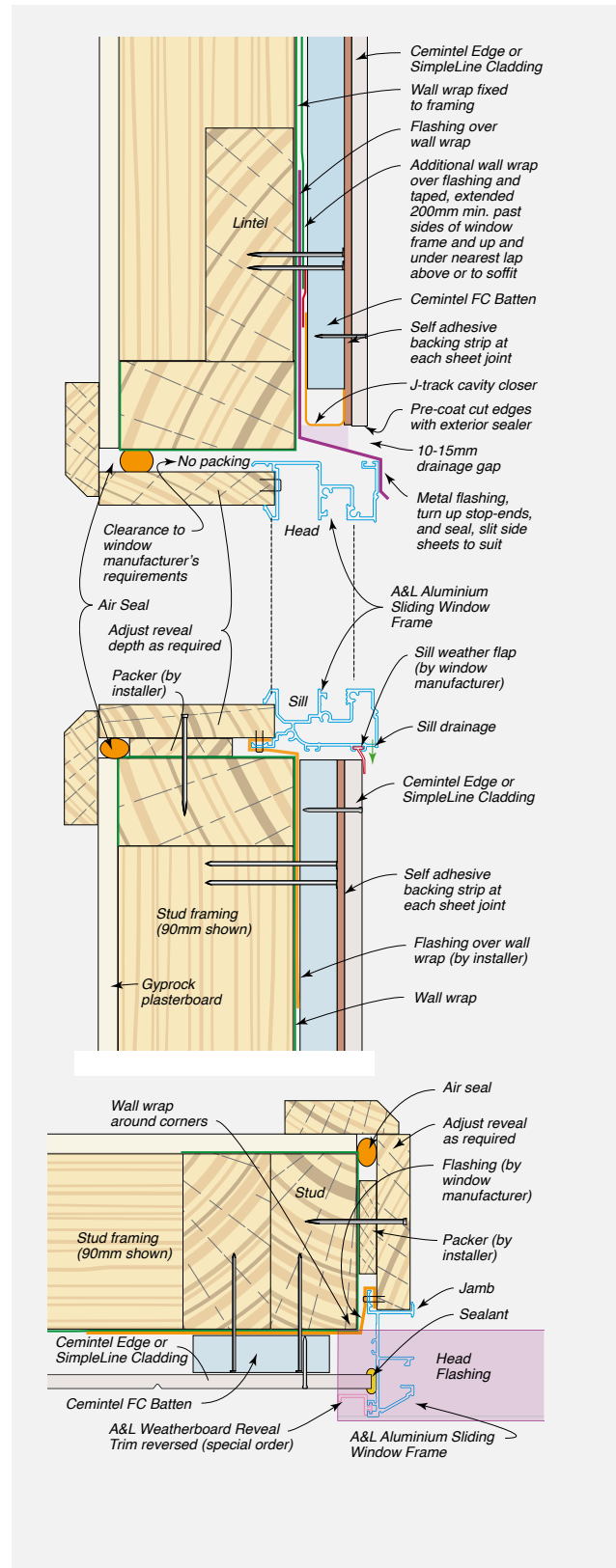

FIGURE 8.65 Typical Sliding Window Installation



CONSTRUCTION DRAWINGS AND DETAILS



Edge Cladding + SimpleLine Vertical Installation – Cavity Fix System

FIGURE 8.66 Typical Sliding Door Installation

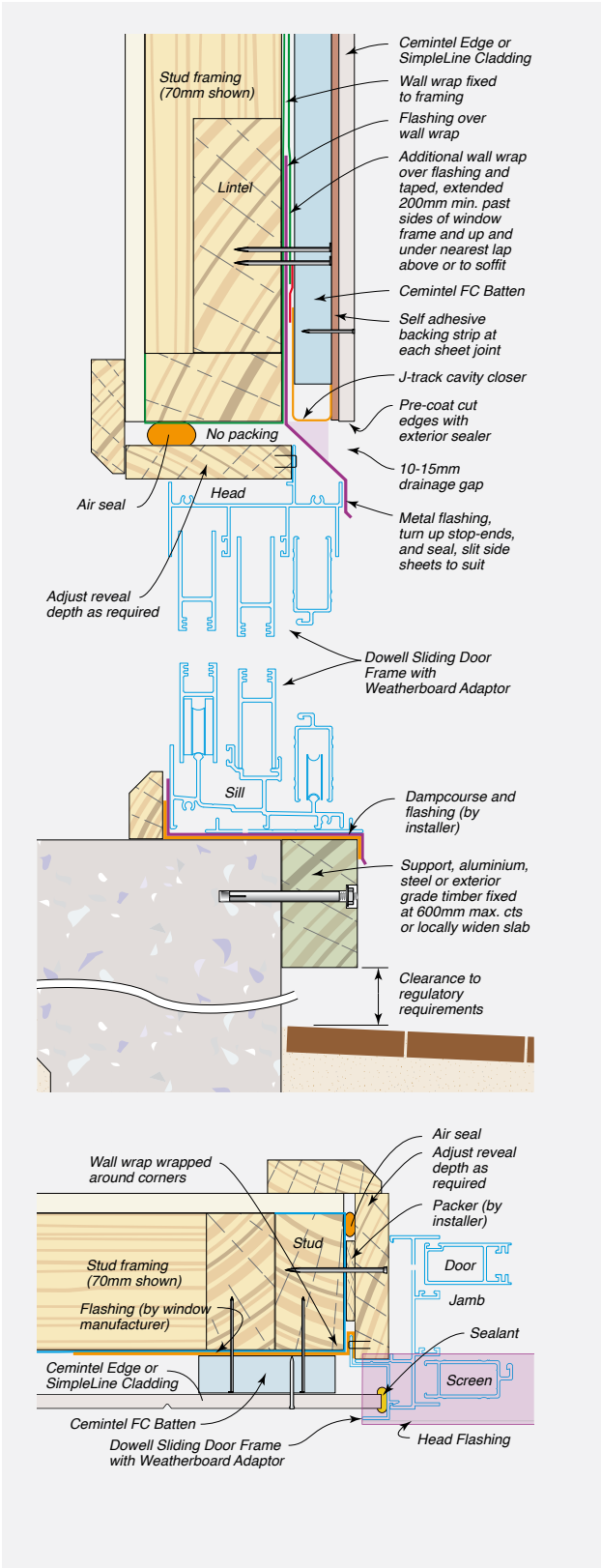



CONSTRUCTION DRAWINGS AND DETAILS

Edge Cladding + SimpleLine Vertical Installation – Cavity Fix System

FIGURE 8.67 Typical Power Meter Box – Recessed Installation

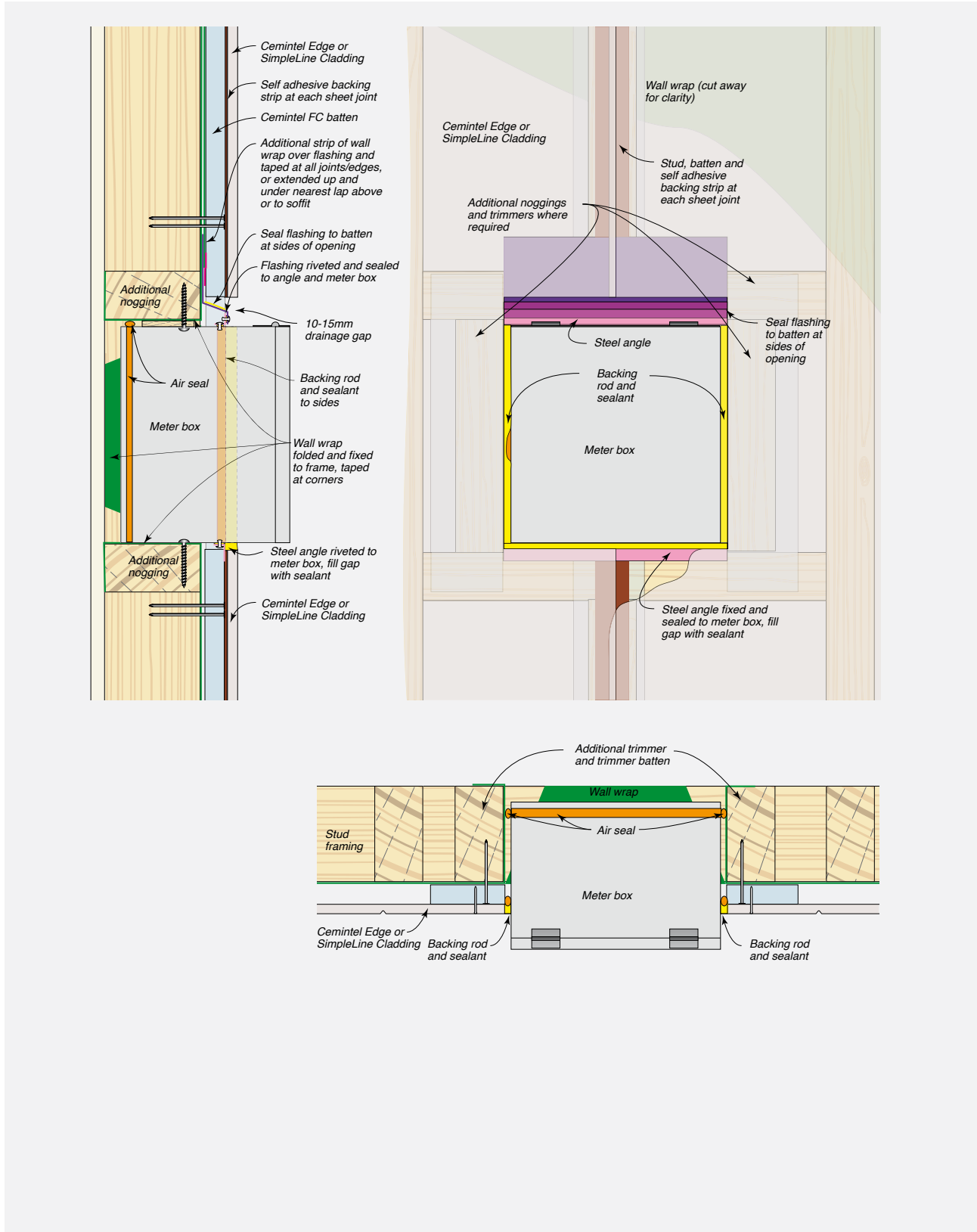

CONSTRUCTION DRAWINGS AND DETAILS



Edge Cladding + SimpleLine Vertical Installation – Cavity Fix System

FIGURE 8.68 Typical Power Meter Box – Face Fix Installation

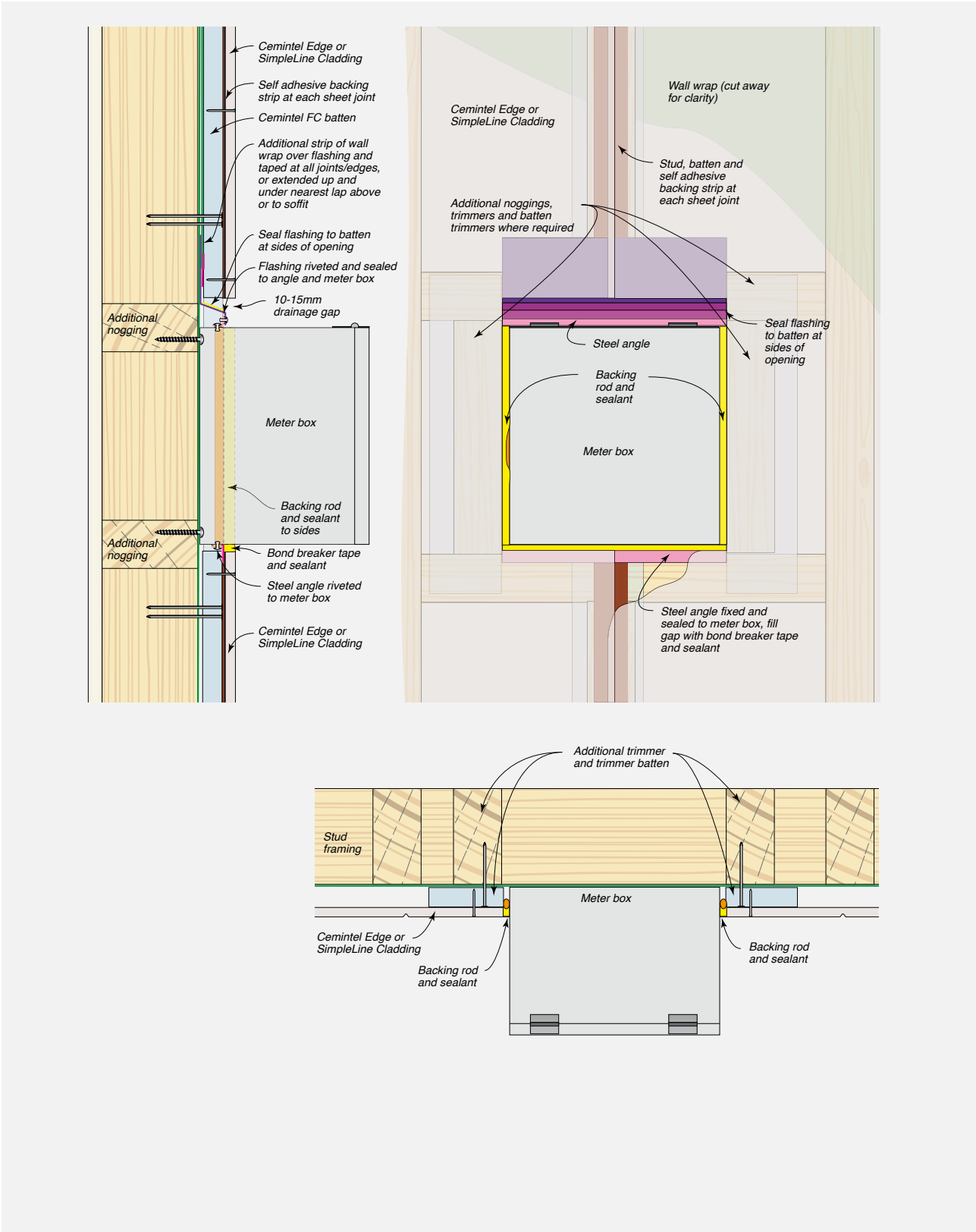



CONSTRUCTION DRAWINGS AND DETAILS

Edge Cladding + SimpleLine Vertical Installation – Cavity Fix System

FIGURE 8.69 Typical Edge Cladding Fire Rated Cavity Fix Wall System Layout

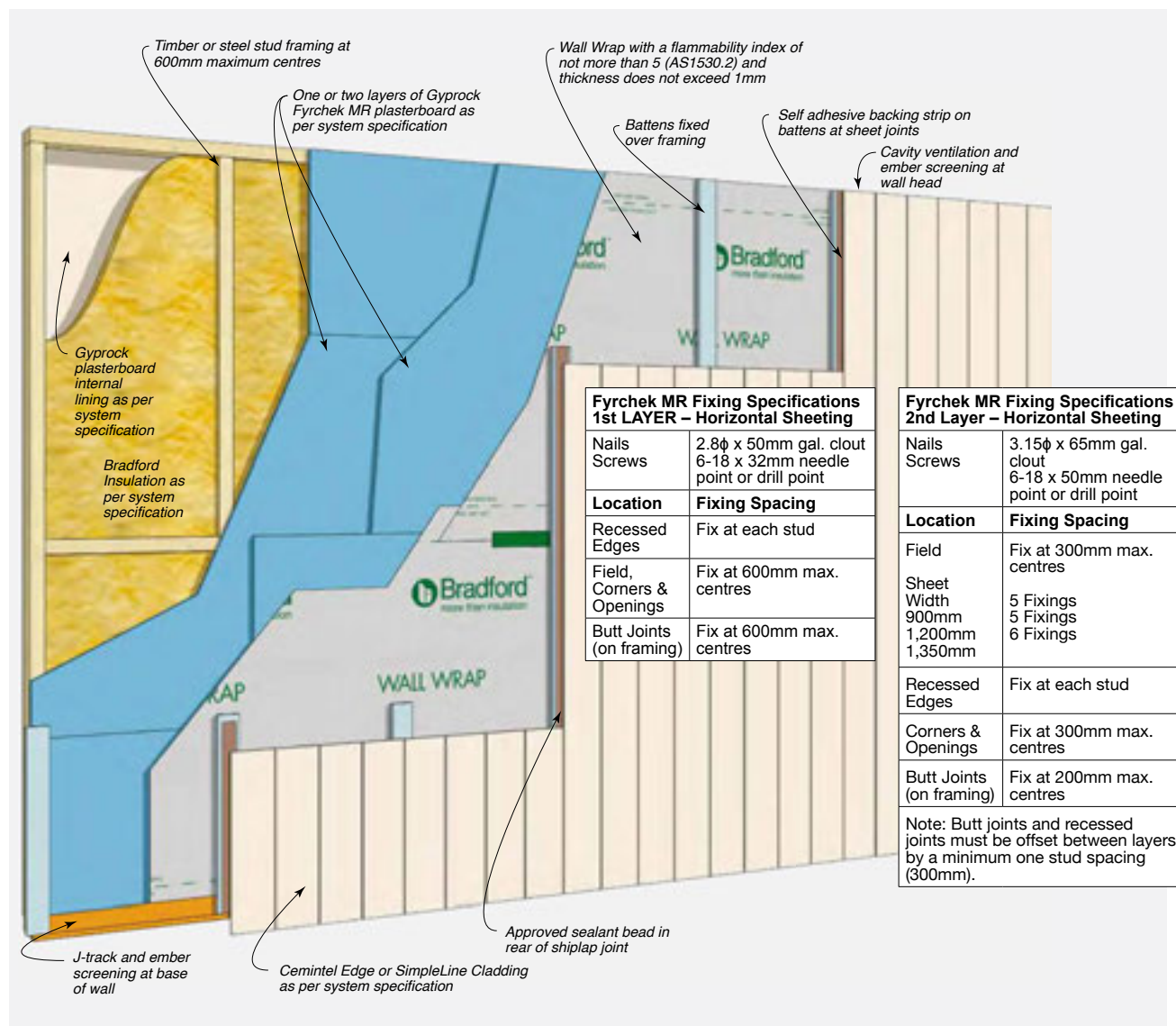

NOTE: The length of the Cemintel cladding fixings will need to be increased to ensure the same or greater embedment depth for single and double fire-rated linings. Nail fixing through multiple layers can be difficult and screw fixings are the preferred method of construction.

CONSTRUCTION DRAWINGS AND DETAILS



Drawings Index – Edge Cladding Horizontal Installation

SECTION	DESCRIPTION	FIGURE REFERENCE	PAGE NUMBER
DIRECT FIX			
	Typical Cemintel Edge Horizontal Installation – Direct Fix Cladding to Framing	8.70	62
	Typical Direct Fix timber - Vertical Joint	8.71	62
	Typical Direct Fix Ribbon Cladding timber – Horizontal Joint	8.72	62
	Typical Direct Fix V Groove Cladding Timber – Horizontal Joint	8.73	62
	Typical Direct fix V Groove Cladding to Horizontal Structural Framing	8.74	62
	Typical Direct Fix DBL s/stud – Vertical Joint	8.75	63
	Typical Direct Fix Ribbon Cladding to steel stud – Horizontal Joint	8.76	63
	Typical Direct Fix V Groove Cladding to steel stud – Horizontal Joint	8.77	63
	NEW: Direct Fix connection layout to framing	8.78	63
CAVITY FIX			
	Typical Cemintel Edge Horizontal Installation – Cavity Fix Cladding to Framing	8.79	64
	Typical Cavity Fix Cladding to Batten – Vertical Joint	8.80	64
	Typical Cavity Fix Cladding to Timber Stud- Vertical Joint	8.81	64
	Typical Cavity Fix Cladding to Batten – Vertical Joint	8.82	64
	Typical Cavity Fix Cladding to Batten – Horizontal Joint	8.83	64
	Typical Cavity Fix Cladding to Timber Stud – Horizontal Joint	8.84	65
	Typical Cavity Fix Cladding to Steel Stud – Horizontal Joint	8.85	65
	Typical Cavity Fix Cladding to Tophat – Vertical Joint	8.86	65
	Typical Cavity Fix Cladding to Tophat - Horizontal Joint	8.87	65
	NEW: Cavity fix connection layout to framing	8.88	65

NOTE: Please refer to Edge Cladding + SimpleLine vertical installation section for the below construction drawings and details.

- Base Details (Refer to pages 37 & 38 for Direct Fix and page 51 for Cavity Fix)
- Corner Details (Refer to pages 38 & 39 for Direct Fix and pages 51 & 52 for Cavity Fix)
- Eaves/Soffit Details (Refer to page 40 for Direct Fix and pages 52 & 53 for Cavity Fix)
- Parapet Details (Refer to page 42 for Direct Fix and page 55 for Cavity Fix)
- Window/Door Details (Refer to page 43 for Direct Fix and pages 56 & 57 for Cavity Fix)
- Meter Box Details (Refer to pages 44 & 45 for Direct Fix and pages 58 & 59 for Cavity Fix)
- Fire Details (Refer to page 46 for Direct Fix and page 60 for Cavity Fix)



CONSTRUCTION DRAWINGS AND DETAILS

Edge Cladding Horizontal Installation - Direct Fix

FIGURE 8.70 Typical Cemintel Edge Horizontal Installation - Direct Fix Cladding to Framing

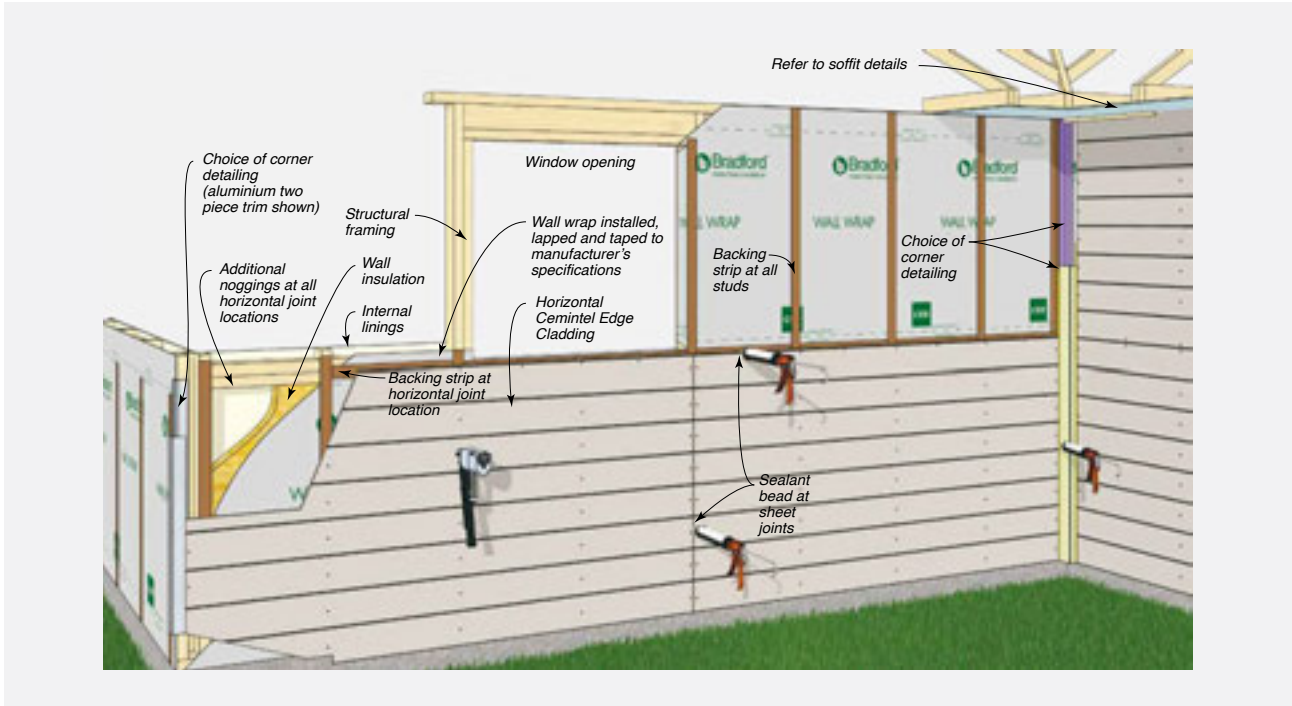

FIGURE 8.71 Typical Direct Fix timber - Vertical Joint

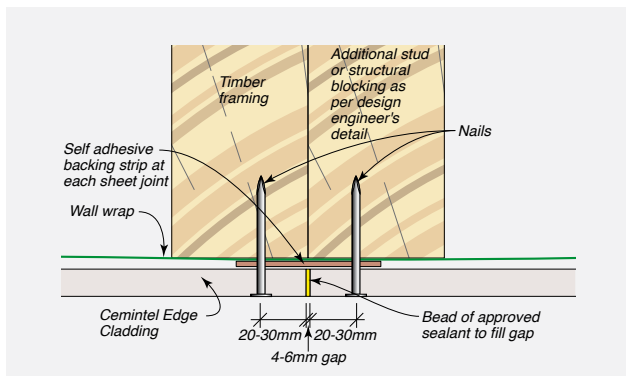

FIGURE 8.73 Typical Direct Fix V Groove Cladding Timber - Horizontal Joint

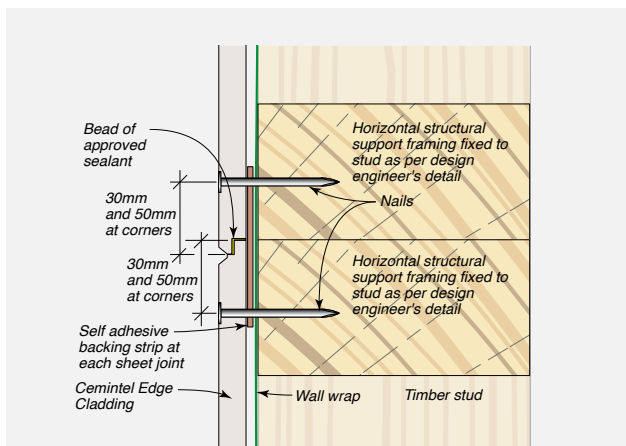

FIGURE 8.72 Typical Direct Fix Ribbon Cladding timber - Horizontal Joint

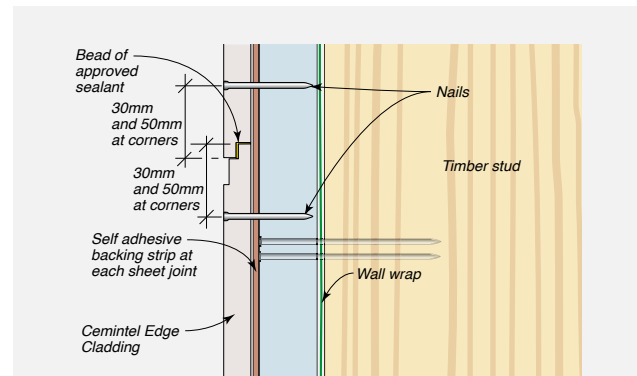
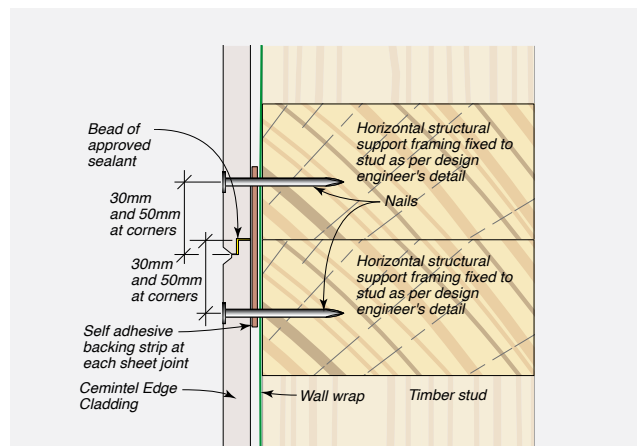

FIGURE 8.74 Typical Direct fix V Groove Cladding to Horizontal Structural Framing



CONSTRUCTION DRAWINGS AND DETAILS



Edge Cladding Horizontal Installation - Direct Fix

FIGURE 8.75 Typical Direct Fix DBL s/stud - Vertical Joint

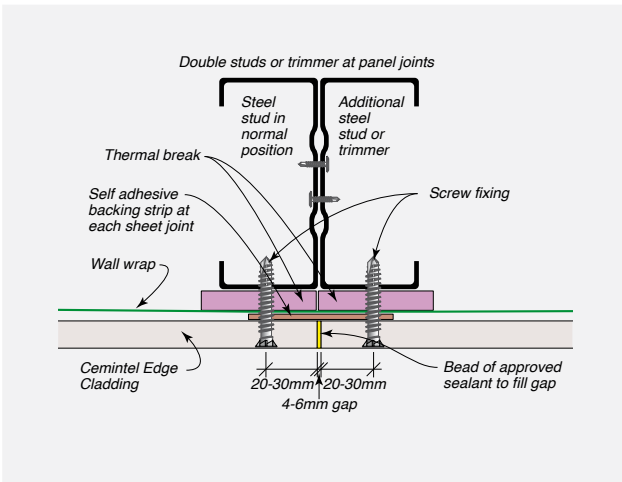

FIGURE 8.76 Typical Direct Fix Ribbon Cladding to steel stud - Horizontal Joint

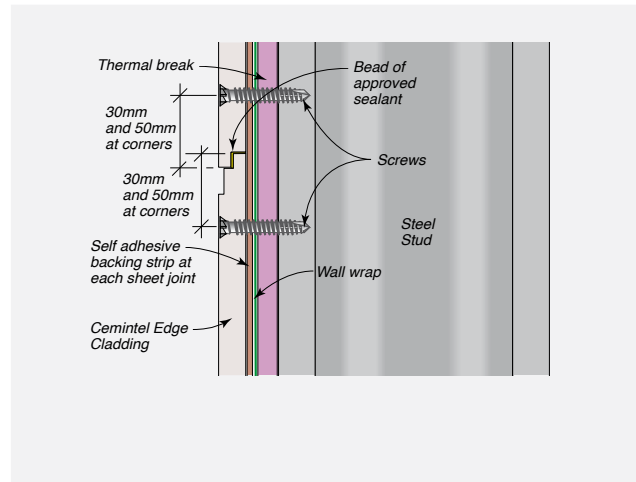

FIGURE 8.77 Typical Direct Fix V Groove Cladding to steel stud - Horizontal Joint

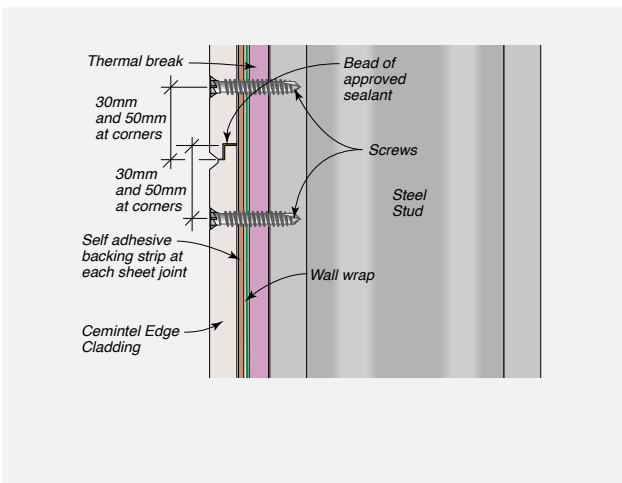
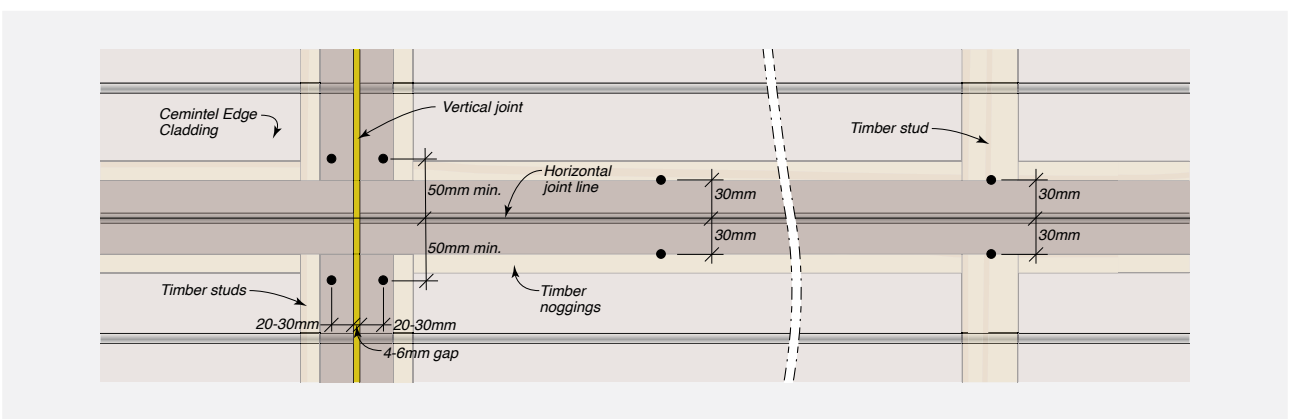

FIGURE 8.78 NEW: Direct Fix connection layout to framing





CONSTRUCTION DRAWINGS AND DETAILS

Edge Cladding Horizontal Installation – Cavity Fix

FIGURE 8.79 Typical Cemintel Edge Horizontal Installation – Cavity Fix Cladding to Framing

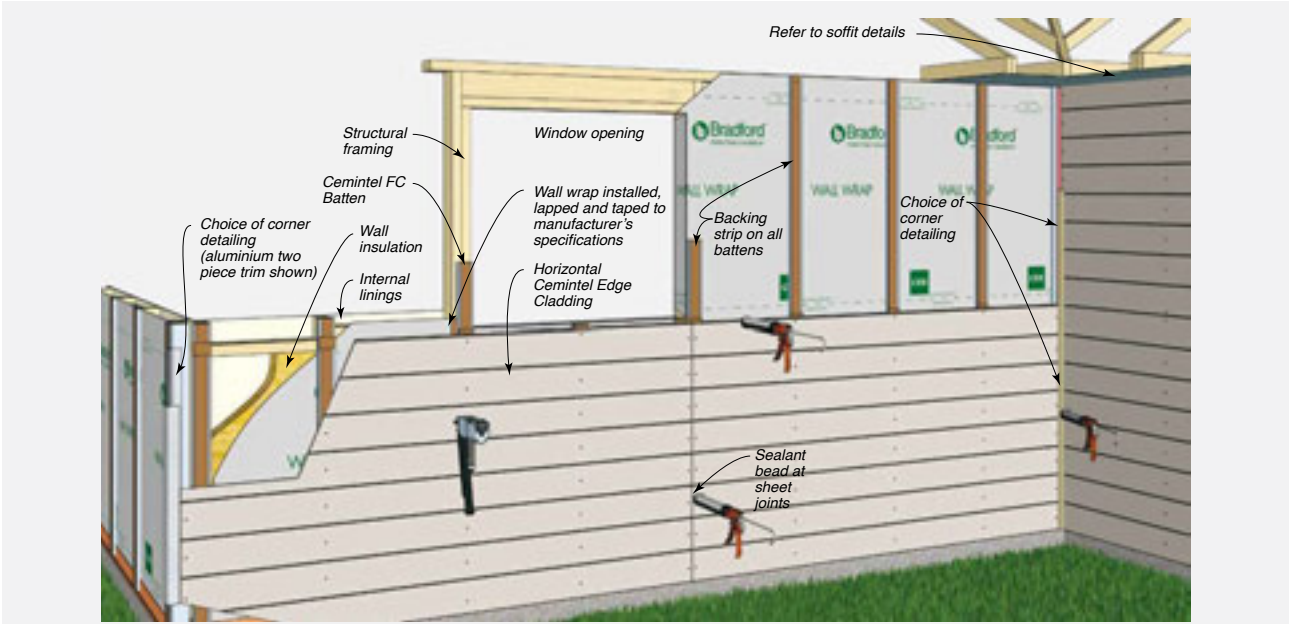

FIGURE 8.80 Typical Cavity Fix Cladding to Batten – Vertical Joint

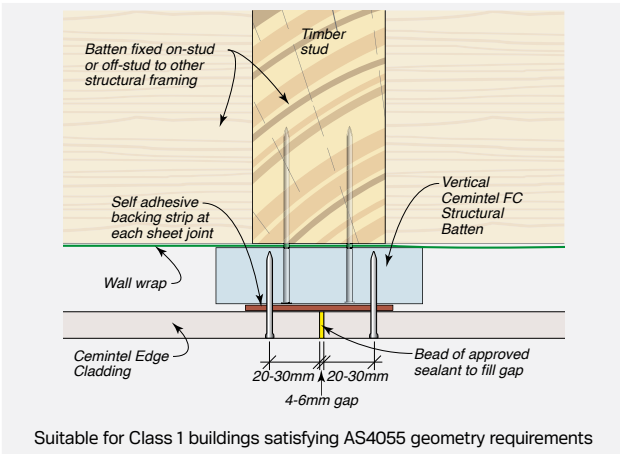

FIGURE 8.82 Typical Cavity Fix Cladding to Batten – Vertical Joint

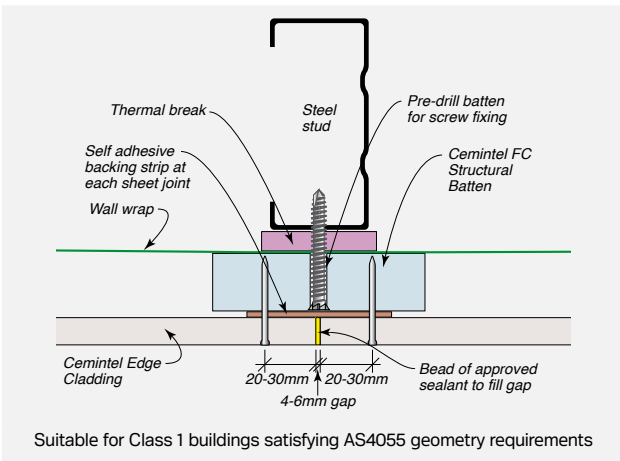

FIGURE 8.81 Typical Cavity Fix Cladding to Timber Stud – Vertical Joint

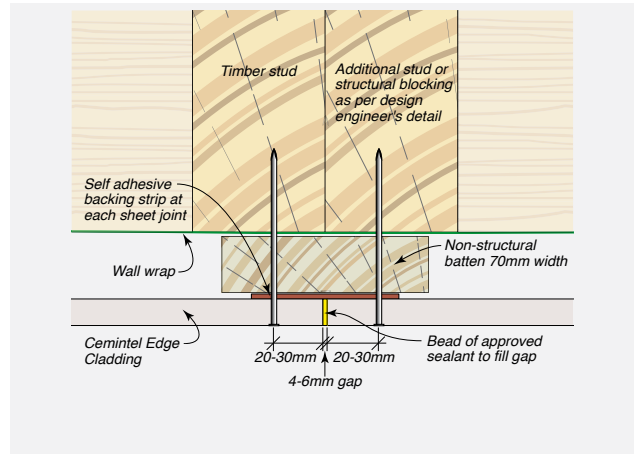
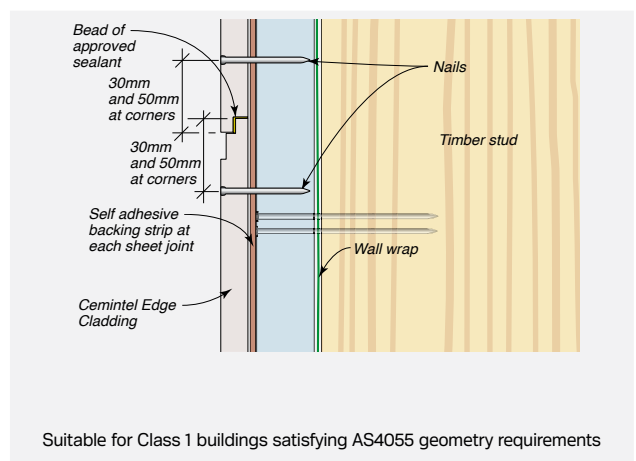

FIGURE 8.83 Typical Cavity Fix Cladding to Batten – Horizontal Joint



CONSTRUCTION DRAWINGS AND DETAILS



Edge Cladding Horizontal Installation - Cavity Fix

FIGURE 8.84 Typical Cavity Fix Cladding to Timber Stud - Horizontal Joint

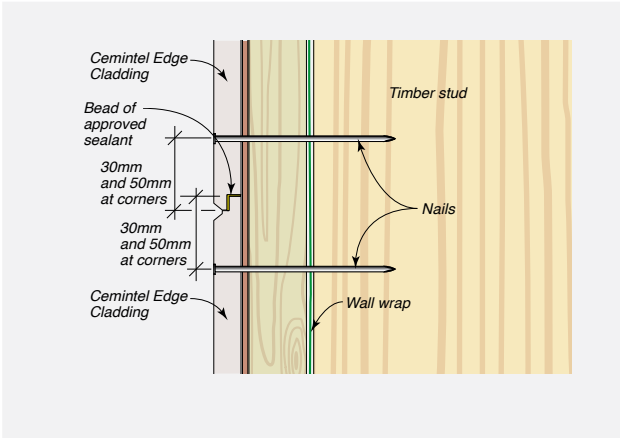

FIGURE 8.85 Typical Cavity Fix Cladding to Steel Stud - Horizontal Joint

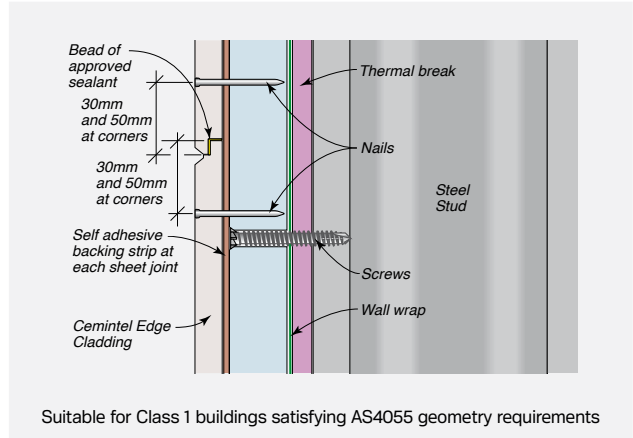

FIGURE 8.86 Typical Cavity Fix Cladding to Tophat - Vertical Joint

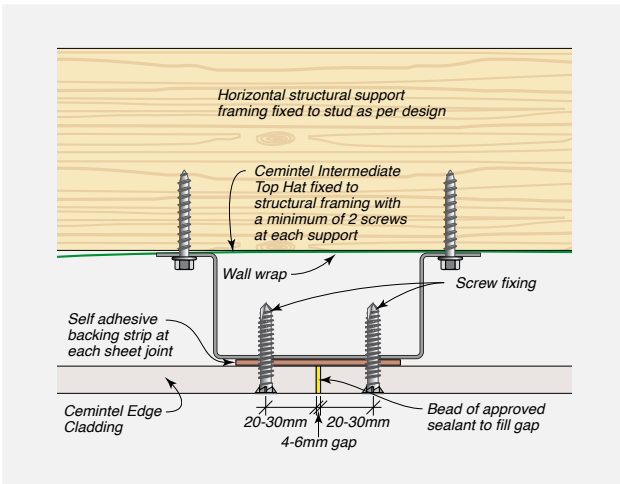

FIGURE 8.87 Typical Cavity Fix Cladding to Tophat - Horizontal Joint

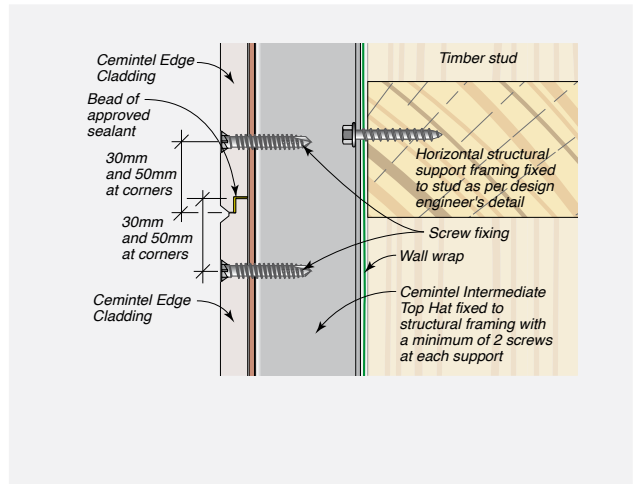
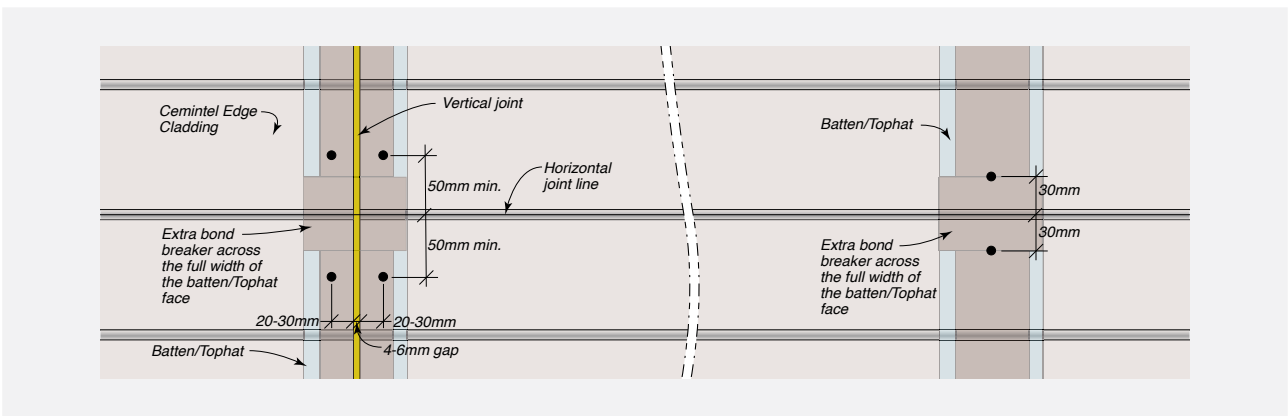

FIGURE 8.88 NEW: Cavity fix connection layout to framing





SAFETY, HANDLING + GENERAL CARE



Health, Safety and Personal Protection Equipment (PPE)

Fibre cement sheets contain silicas that are harmful if inhaled. Protective clothing and breathing equipment should be worn when cutting products.

When cutting, drilling or grinding Edge and SimpleLine sheets using power tools, always ensure the work area is properly ventilated.

An approved dust mask (AS 1715 and AS 1716) and safety glass (AS 1337) must be worn. Cemintel recommends that hearing protection also be worn.

Safety Data Sheet information is available at www.cemintel.com.au



Managing Respirable Crystalline Silica dust

Crystalline Silica is everywhere. It is found naturally in stone, rocks, sand, gravel and clay. Sand is one of the raw materials in Fibre Cement. Respirable Crystalline Silica dust is the fine dust that's created when you use power tools to cut, drill, grind, chip or sand materials and products that contain crystalline

silica. This dust is of concern due to its size as it gets caught deep in your lungs and can cause long term damage.

IF YOU USE THE CORRECT EQUIPMENT FIBRE CEMENT IS SAFE TO USE.

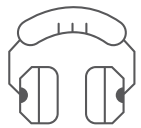

Cemintel Safety Requirements

1 - Cut Outdoors*	The ventilation outdoors is greater than that indoors, and therefore should reduce exposure.
2 - Use On-Tool Dust Extraction	Use on-tool dust extraction when using power tools to drill and cut Fibre Cement, with a vacuum that contains a HEPA M Class filter.
3 - Correct Equipment	Use a plunge saw with a specifically designed Fibre Cement blade
4 - Don't Sweep, Vacuum instead	When completing your work vacuum with a HEPA M Class filter, rather than a broom as sweeping creates more dust.
5 - Use a Respirator	Use a half face P1 or P2 respirator. It is essential that the respirators are Fit Tested and workers are cleanly shaven to obtain a good seal

* Even though not recommended, indoor cutting can be completed when using an onsite cutting room with exhaust ventilation and a M class filter at a minimum, on-tool dust extraction with a vacuum with a HEPA M Class filter, a Full Face P2 respirator and conducting local occupational and static air monitoring to validate effectiveness of control measures.

Handling & General Care

Storage

All Edge and SimpleLine sheets must be stacked flat, clear of the ground and supported at 450mm maximum centres on a level platform. Sheets must be kept dry, preferably stored inside the building. Sheets must be dry prior to fixing, hence if they are to be stored outside, the sheets must be protected from the weather. Sheets exposed to moisture prior to installation may be subject to shrinkage, and voiding of warranty.

Handling

Edge and SimpleLine sheets and corners are treated products and must be handled with care during handling so as to avoid damage to edges and ends. Sheets should be carried horizontally on edge by at least two people.

Cutting

Sheets should be cut from the back using a power saw. Cemintel recommends using the Makita Plunge Saw Kit (1300KW) with guide rail and appropriate blade.

All exposed cut edges **MUST BE SEALED TO PREVENT MOISTURE ABSORPTION**. Refer to 'Components' table for appropriate materials.

Penetrations

Penetrations in sheets may be cut or drilled prior to installation. Cut from the back or drill from the front. Cut penetrations oversize by 8-10mm all around. Mask, prime and fill gaps with sealant in accordance with recommended methods and products.

WARRANTY, CLEANING + MAINTENANCE

10

Warranty

The Edge and SimpleLine cladding sheets has a product warranty of 10 years.

The full product warranty is available for download at www.cemintel.com.au

Wash Down Process

An external coating system must be applied and maintenance of the coating system shall be in accordance with coating manufacturer's recommendation. The following is recommended as a minimum maintenance regime:

- Where sufficiently exposed, rain can perform a natural wash down of the wall and ongoing maintenance should be limited to occasional rinse down or using a soft cloth or soft brush (like a dust pan brush).
- Walls which are protected by soffits above must be washed down twice per year to remove salt and debris build up particularly at joints.
- Normal dirt can be removed with a soft brush and warm water up to 50degrees, to which a small amount of dishwashing liquid or soap has been added. The sheets should be rinsed with clear water before they dry.
- Calcifications should be removed with a 5% sulfamic acid solution or with a commercial lime remover. The façade should be rinsed with clear water after cleaning.
- Sheets discoloured by algal growth should be treated with an algicide without bleaching agents. This application should be allowed to take effect for several days. Afterwards, clean the sheets using the 'normal dirt' procedure above.
- When rinsing down sheets, use no more than 700 psi (50kg/cm²) of water pressure at a minimum of 3m to 3.5m distance from the face of the wall. Water pressure should be applied downward to avoid forcing water into joints and gaps.
- Use neutral detergent with a soft cloth or soft brush when removing dirty spots from a panel. When diluting the neutral detergent, follow the manufacturer's instructions and use the weakest solution possible.

Inspection, Repair and Maintenance

The durability of the Cemintel Edge and SimpleLine cladding system can be enhanced by periodic inspection and maintenance. Inspections should include examination of the coatings, flashings and seals. Any cracked or damaged finish or seals which would allow water ingress must be repaired immediately by resealing the affected area, or by removing the panel and replacing sealant. Any damaged flashings, sheets or sealant must be replaced as for new work.

Regularly inspect panel surfaces and follow washdown procedures when required.

Ensure ventilation and drainage gaps between sheets and flashings are clear of any debris.

It is recommended storing additional sheets in case any sheets are damaged in the future.



Our Offices

Sydney

376 Victoria Street
Wetherill Park NSW 2164

Melbourne

277 Whitehall Street
Yarraville VIC 3013

Brisbane

768 Boundary Road
Coopers Plains QLD 4108

Adelaide

Lot 100 Sharp Court
Mawson Lakes SA 5095

Perth

19 Sheffield Road
Welshpool WA 6106

Hobart

11 Farley Street
Derwent Park TAS 7009

Darwin

Cnr Stuart Highway
& Angliss Street
Berrimah NT 0828

cemintel.com.au

1300 236 468

For Design and Technical Support:

DesignLINK – 1800 621 117

Cemintel is a trading entity of CSR Building Products Limited (ACN 008 631 356).

Disclaimer: Information presented in this document is supplied in good faith and to the best of our knowledge, was accurate at the time of preparation. Products are subject to natural variation as part of the manufacturing process. Product images may vary from actual product in regard to colour and surface finish. The provision of this information should not be construed as a recommendation to use any of our products in violation of any patent rights or in breach of any statute or regulation. Users are advised to make their own determination as to the suitability of this information in relation to their particular purpose or specific circumstances. Since the information contained in this document may be applied under conditions beyond our control, no responsibility can be accepted by Cemintel, or its staff for any loss or damage caused by any person acting or refraining from action as a result of misuse of this information.

04/2022

CSR